

# LONG POLES

For each match angler, the presentation of the new pole is an exciting and interesting event, which marks the passing of the seasons as a natural calendar. For us of Trabucco Team is above all a challenge and a responsibility. We must move forward and not to disappoint the expectations of the fans, who for thirty years put their trust in the brand, and we would never compromise, because finding the middle ground always involve

some sacrifice. Instead, we want to reach positive solutions on all fronts: in the lightness, in balance, strength and performance. With the important contribution of Reglass, we have succeeded once again, hoping that the impact of the new collection will remain in the memory of everyone, being the perfect premise for a match season full of satisfaction.

# GNT

## 95 MATCH ONE

### NEW 995 MATCH ONE GNT

## TRABUCCO 995 MATCH ONE GNT

It's the first lady among the Trabucco poles, the one that likes to be waited to get the applause of international match fishing scenario.

Unlike the top models, it has no curves to display, because it is straight and stiff as everyone would have dreamed of, as fast as the thoughts of the most advanced user. The slimming cure, programmed by Trabucco technicians and applied by Reglass engineers, led to a butt diameter of only 43 mm, with a nearly cylindrical profile of the three bottom sections, whose firmness is actually unbeatable. The new geometry of the last six meters on top has generated an unprecedented reactivity, the shortest way to get in time on hardest bites, those which can be hit only if you even anticipate the strike. From the top, the long AB tip of 150 cm, which replaces the traditional sections 1 and 2, is stiffened by internal Magic Steps and features a 2,2 mm top bore. Follow the new sections 3, 4 and 5, made from a very sophisticated material to compensate the weight due to larger diameters, without missing the resistance. On the bottom area of section 3, a special structural reinforcement allows drilling a hole to create the Strippa kit, a solution which is more and more on demand even on silver fish poles, since it's culture is gradually growing. Then sections 6 and 7, which can be replaced by those of the Safety Kit in case of extreme fishing and accept the specific mini extension. Finally, the sections 8 and 9, handles for the 11,50 and 13 meters,

which are also served by a mini extension. As these sections have a very small taper and cannot accommodate section 7, inside the holdall the pole occupies three tubes. While fishing at 11,50 meters, it is advisable to remove the section 8 (11,50 butt) and insert the 13 meter's handle in the section 7, thus handling a stronger butt. The

pole is supplied with three 5,83 meters extra long kits, all belonging to match class with the AB tip, identical to the one fitted into the pole. Two mini-extensions, fitting sections n. 6-7-8-9, are also included as well as the cupping kit, made of three sections with a long top to offer the same length of a traditional four sections match kit.

Code	Description	Length	Ø	C. Length	Wt	Sections
139-55-200	GNT 995 Match One Full Package	13.00	-	-	-	-
139-55-210	GNT 995 Match One 13.00 m	13.00	42	185	970	8

Code	GNT 995 ACCESSORIES	Sections	Length
139-55-010	GNT X95 Top Kit 4 Match (AB/3/4)	3	4,20
139-55-020	GNT X95 Top Kit 5 Match (AB/3/4/5)	4	5,80
139-55-030	GNT X95 Top Kit 4 Strong (AB/3/4)	3	4,20
139-55-040	GNT X95 Top Kit 5 Strong (AB/3/4/5)	4	5,80
139-55-050	GNT X95 Cupping Kit 2	2	-
139-55-055	GNT X95 Multi-Section 4	1	-
139-55-060	GNT X95 Power Kit 2	2	-
139-55-070	GNT X95 Safety Sections 6 & 7	2	-
139-55-080	GNT X95 Mini Extension 13	1	-
139-55-090	GNT X95 Mini Extension 6/7	1	-

#### POLE PACK

- GNT 995 Match One 13 m
- Kit 5 Match
- Safety Sections 6 & 7
- Mini Extension for 13 m butt
- Mini Extension for sections 6 & 7
- Cupping Kit 3 sections
- XPS Pole Pots
- Protective tubes & GNT Holdall

### REGGLASS FEATURES



The Anti-Friction System is a particular process that during the production "prints" on the section a microscopic rough mat layer. This layer offers several improvements to the pole, such as easier shipping and unshipping, lighter section and improves the long-lasting.



Nanolith is a special resin with a nanometric particles, who can easily insert themselves into carbon filaments and epoxy resin assuring this way an improvement of the mechanical characteristics. This to obtain an even more prompt action which results more stable and lighter pole.



Fusion is two high modulus carbons fused together as one whilst wrapped on the mandrel. The end result being ultra rigid top kits with no tip bounce, allowing the angler to hit lightning fast bites with ease.



The Tefflon Joints consists in a Teflon coating resin applied onto the male joint. This coating prevent a longer lasting on the section and a perfect precision of the fittings. It also avoid the joints to get stuck when wet or dirty. This concept is applied both on the original sections of the poles and the spare kits.



PARALLEL SECTIONS CONCEPT

MULTI-TIP SYSTEM

MINI EXTENSION

SF SECTIONS



13m Long Pole with 2 Parallel Butt Sections



Safety Sections n.6 and n.7



3 Kit 5 Match



3 sections Competition Cup Kit (total length 4.40m equal to a match top 4)



Reversible Short Extension fitting into sections 6-7



Short Extension fitting into butt section.



**MAGIC STEPS**  
**PATENT PENDING**  
Present in the 2 and 1 sections, this new technology is an industry first providing the angler with a silky smooth elastic system. A series of teflon coated inner steps prevents the elastic from making contact with the inner wall of the pole sections, substantially reducing elastic stick, allowing the elastic to gather quickly.



The Clean Caps are made of medium density foam, and have a double utility: every time the male section is fitted, the lips of the Clean Caps clean the inner part of the joint, avoiding dangerous scratches by the sand or dust. In addition to that, once fitted in the male joint, they seal the section avoiding them to sink.



A carbon and resin treatment providing an anti-friction finish that enables the pole to be shipped with incredible ease during wet or dry conditions. This revolutionary surface not only adds strength, but also protects the overall fishing action during hot and cold temperatures

# NEW GNT 975 XTR COMPETITION

An immediate feeling of lightness and manageability is the result of the first contact with the pole.

In the new 975, evolution of the 845, the elastic response of the upper area helps to facilitate operations, as it dampens the abnormal fluctuations, while making fishing with light and ultra-light rigs extremely enjoyable, classic when tackling top water fishing but also in the difficult canal days. The satin silver butt colour promises well for the summer season, when the sun rays can bring the carbon at unbearable temperatures, making it difficult to control poles with dark color handle. The rod consists of nine sections, with traditional tip, whose possible cut is balanced by the mini extension to serve the 13 meters handle. A second mini extension fits sections 8, 7 and 6, forming a sturdy handle in the case of closer fishing lines. The two butt sections of 13 and 11,50 meters have almost no taper to develop an outstanding stiffness; in case of fishing at 11,50 range it is recommended to replace

the butt with that of 13 meters for a total security. At the base of the section 3, a structure reinforcement has been prepared to protect it in the event that the user decides to drill the hole intended for elastic extraction during the fish fight (Stripa Kit). Design and production have been carried out with extreme care: to note the woven carbon joint's structure, material with extraordinary properties of abrasion resistance and durability. The Trabucco A.S.E.F. surface finish brilliantly eases the sliding of the rod through hands, even in wet conditions. All sections of the rod are interchangeable with those of the GNT 775, and a wealth of standard equipment is provided with the pole: three Match kits of 5 sections for almost 6 meters long, a cupping kit long as a 4 sections match kit, a Safety Set consisting of additional sections 5-6-7, reinforced to replace the standard ones in case of heavier fishing.

Code	Description	Length	Ø	C. Length	Wt	Sections
139-49-100	GNT 975 XTR Comp. Full Package	13.00	-	-	-	-
139-49-110	GNT 975 XTR Comp. 13.00 m	13.00	44	185	960	9

Code	GNT 975 ACCESSORIES	Sections	Length
139-49-010	GNT XTR X75 * Competition Top Kit 4	4	4,35
139-49-020	GNT XTR X75 * Competition Top Kit 5	5	5,95
139-49-030	GNT XTR X75 * Carp Top Kit 3 (Power Kit+4)	3	4,35
139-49-040	GNT XTR X75 * Carp Top Kit 4 (Power Kit+4+5)	4	5,95
139-49-050	GNT XTR X75 * Power Kit 2	2	2,95
139-49-055	GNT XTR X75 * Cup Kit 2	2	2,95
139-49-060	GNT XTR X75 * Safety Section Set (5/6/7)	3	-
139-49-070	GNT XTR X75 * Mini Extension 13	1	-
139-49-080	GNT XTR X75 * Mini Extension 6/7	1	-

## POLE PACK

- GNT 975XTR Competition 13 m
- Kit 5 Match
- Safety Sections 5-6-7
- Mini Extension for 13 m butt
- Mini Extension for sections 6-7-8
- Cupping Kit 3 sections
- XPS Pole Pots
- Protective tubes & GNT Holdall

TRABUCCO

975

COMPETITION

GNT

## TECHNOLOGY 975 & 775

### JOINT & SECTION ALIGNMENT

All pole's sections are produced by rolling the carbon sheet around a mandrel. Such operation leaves an external trace along the section, just where the carbon sheet has been cut. That visible line is known as "spine", because it's a stiffer area, playing same role of the human's backbone. Before starting fishing, it's important to align the spines of all sections, in order to let them cooperate correctly; for this reason, the new GNT 975 and 775 poles feature specific indicators, which show the section's number and ease the spine alignment. Fishing with those indicators facing upwards makes the pole far more sharp and definitely stronger.



### MATCH & CARP KIT

In order to be competitive in carp commercials and waters that hold extra large fish, it's worth to install the elastic under Stripa mode, with the chance to adjust its tension during the fight. The elastic gets through the top sections of the pole and get off the side hole, located at the base of the section 3. The tension of the elastic is adjusted instant by instant, by pulling it out from the hole with the free hand or releasing it when the fish reacts with a sudden run. In the GNT 975 and 775 new poles, the Carp Kit are already equipped with large 4 mm hole, SiC lined for total protection, while the Match Kit are prepared with a reinforced segment.

### STRIPPA SYSTEM

CARP KIT

MATCH KIT



Stefano Bosi

13m Long Pole with 2 Parallel Butt Sections



Safety Sections n.5, 6 and 7



3 kit Match of 5 Sections



3 sections Competition Cup Kit (total length 4.40m equal to a match top 4)



Reversible Short Extension fitting into sections 6 and 7



Short Extension fitting into butt section.



**NEW** GNT ST STATION



MODULAR SYSTEM

*Elegance, stability, comfort*

New seatbox that takes the aluminium frame from 925 model, but gets a new dressing with a fashionable grey finish. Regarding stability, which was already impressive, another step forward has been done thanks to the tubular links to legs. An explosive mix of elegance and comfort, made even more interesting by the trolley kit included.



Find out more on page 290

# NEW 795 CARP 1 ONE GNT

It is the most qualified answer to the expectations of the top match angler, who needs to combine GNT 995 with a second pole to always feel ready in case of emergency or to safely face those match venues that increasingly offer opportunities for extreme fishing, in alternative to traditional silver fish bags.

Among the most difficult conditions, today we must count fishing with large flat floats, that more and more often solves seemingly difficult matches, but put the pole under heavy stress. For those who take part in team matches, with some funny experience at commercial lakes, the 795 becomes a great rod for all situations, because it accepts light match kits of the 995, allowing to build up a truly comprehensive range of options. Produced in Italy by Reglass, this new pole integrates seamlessly with top of the range GNT 995, allowing the interchange of all sections. Since it provides the AB tip of 150 cm, the GNT 795 also consists of 8 elements, with the two cylindrical profile butts with only 43 mm diameter, and is stored into three tubes. The three kits supplied are of the Strong class, exactly same as the one that is part of the rod, and are made of four sections for a length of 5.80 meters. The cupping kit in three sections, provided with the rod's package, has identical length to a normal kit of four sections. A mini extension

allows to compensate for any chopping of the tip, while a special reinforcement at lower end of section 3 allows to drill the hole needed to create a Strippa Kit, now pre-

vious to be truly competitive in commercial carp field as well as in all waters that are home to challenging fish.

Code	Description	Length	Ø	C. Length	Wt	Sections
139-55-300	GNT 795 Carp One Full Package	13.00	-	-	-	-
139-55-310	GNT 795 Carp One 13.00 m	13.00	43	185	1025	8

Code	GNT 795 ACCESSORIES	Sections	Length
139-55-010	GNT X95 Top Kit 4 Match (AB/3/4)	3	4,20
139-55-020	GNT X95 Top Kit 5 Match (AB/3/4/5)	4	5,80
139-55-030	GNT X95 Top Kit 4 Strong (AB/3/4)	3	4,20
139-55-040	GNT X95 Top Kit 5 Strong (AB/3/4/5)	4	5,80
139-55-050	GNT X95 Cupping Kit 2	2	-
139-55-055	GNT X95 Multi-Section 4	1	-
139-55-060	GNT X95 Power Kit 2	2	-
139-55-070	GNT X95 Safety Sections 6 & 7	2	-
139-55-080	GNT X95 Mini Extension 13	1	-
139-55-090	GNT X95 Mini Extension 6/7	1	-

### POLE PACK

- GNT 795 Carp One 13 m
- Kit 5 Strong
- Mini Extension for 13 m butt
- Cupping Kit 3 sections
- XPS Pole Pots
- Protective tubes & GNT Holdall



# NEW GNT 775 XTR MATCH CARP

Designed to carry out the heavy work in the normal match fishing and to succeed in the commercial carp circuit, during field tests it has proved to be a great rod for silver fish as well, thus being the ideal solution for the angler that wants an allrounder pole, allowing to easily jump from a 1 mm solid elastic to a 3 mm hollow one.

For this reason, the only appellation "Carp" would have been an understatement, and so the rod also reports the name "Match". Unlike the 975, this pole has the AB top section, 150 cm long, while section 3 features the reinforcement to make the hole for elastic extraction during the fish fight (Strippa System). The rod has interchangeable sections with those of the GNT 975, including the parallel butt sections, sharing with it the woven

carbon cloth reinforced joints and A.S.E.F. finishing for easy slipping between hands. The package includes three Carp class kits, 4,35 meters long, a 2,90 meters long cupping kit and two mini extensions. The first is useful to recover the length lost in the eventual chopping of the top section, while the second fits sections 6 and 7, protecting their lower end in case of fishing at 10 or 11,50 meters range.

Code	Description	Length	Ø	C. Length	Wt	Sections
139-49-200	GNT 775 XTR Match Carp Full Package	13.00	-	-	-	-
139-49-210	GNT 775 XTR Match Carp 13.00 m	13.00	45	185	970	8

Code	GNT 775 ACCESSORIES	Sections	Length
139-49-010	GNT XTR X75 Competition Top Kit 4	4	4,35
139-49-020	GNT XTR X75 Competition Top Kit 5	5	5,95
139-49-030	GNT XTR X75 Carp Top Kit 3 (Power Kit+4)	3	4,35
139-49-040	GNT XTR X75 Carp Top Kit 4 (Power Kit+4+5)	4	5,95
139-49-050	GNT XTR X75 Power Kit 2	2	2,95
139-49-055	GNT XTR X75 * Cup Kit 2	2	2,95
139-49-060	GNT XTR X75 * Safety Section Set (5/6/7)	3	-
139-49-070	GNT XTR X75 * Mini Extension 13	1	-
139-49-080	GNT XTR X75 * Mini Extension 6/7	1	-

### POLE PACK

- GNT 775XTR Match Carp 13 m
- Kit 4 Carp
- Mini Extension for 13 m butt
- Mini Extension for sections 6 & 7
- Cupping Kit
- XPS Pole Pots
- Protective tubes & GNT Holdall



PARALLEL SECTIONS CONCEPT

MULTI-TIP SYSTEM

MINI EXTENSION



13m Long Pole with 2 Parallel Butt Sections



3 kit Strong of 4 Sections (5.80m)



Cupping kit of 3 Sections (total length 4.20m equal to a match top 4)



Mini Extension for 13m butt.



## GNT 745 XTR CARP

It has been designed and structured to bear any sort of load and stress, but, at the same time, balanced and easy to use thanks to the employment of high modulus carbon and nano resins which are able to evenly disperse between carbon layers, even if used in a very limited amount.

The resulting action is quite sharp, with excellent shock absorbing capacity due to the cooperation between carbon sheets. In front of such power, carp, barbel, clarius and mullet rapidly understand that it's not the case to waste any energy during the fight. Elastic rating starts from size 10 to go up hollow models and double ones, practically the whole world of strength. This pole fits the traditional top section (60 cm long), linked by

telescopic joint to second section; in case it is removed, any big elastic works even better through 4 mm top bore of the second section, also because it's obviously stiffer than the standard top. All sections are slide finished for a smooth use and display woven carbon reinforced joints to last forever.

Code	Description	Length	Ø	C. Length	Wt	Sections
139-48-200	GNT 745 XTR Carp Full Package	13.00	-	-	-	-
139-48-210	GNT 745 XTR Carp 13.00 m	13.00	46	175	990	9

Code	GNT 745XTR ACCESSORIES	Sections	Length
139-48-030	GNT XTR X45 * Top Kit 5 Carp	5	6.20
139-48-040	GNT XTR X45 * Top Kit 4 Carp	4	4.60
139-48-050	GNT XTR X45 * Competition PW Kit	2	3.20
139-48-060	GNT XTR X45 * Mini Extension	1	-
139-48-070	GNT XTR X45 * Cupping Kit	2	3.20

### POLE PACK

- GNT 745 XTR Carp 13 m
- Kit 4 Sections Carp
- Cupping Kit
- Mini Extension For Section Nr. 8 and 13 m
- XPS Pole Pots
- Protective tubes & GNT Holdall



## DREAM TEAM XPS TX SLIM MATCH

Extremely thin and light pole, from the great dowries of reliability in a different use.

Made in the length of 9,50 mt. with the possibility of lengthen through an extension to 11,00 mt. Entirely built in HM and high resistance carbon used in the parts more solicated, it results to excellently be balanced and with a notable rigidity despite the great power of catch. Is' a perfect pole for fishing in commercial fishery and in all the competitions where need a very manageable and powerful pole.

### POLE PACK

- Dream Team XPS TX Slim Match 9.50 m
- Extension 11 m
- Kit 4 Sections
- Mini Extension
- Protective Tubes & Holdall

Code	Description	Length	Ø	C. Length	Sections
139-66-100	D.T. XPS TX Slim Match Full Package	11.00	42	170	7

Code	XPS TX SLIM MATCH ACCESSORIES	Sections	Length
139-66-001	D.T. XPS TX Slim Match * Power Kit	2	2.80
139-66-003	D.T. XPS TX Slim Match * Kit 4 Section	4	4.45
139-66-004	D.T. XPS TX Slim Match * Mini Extension	1	-

## NEW DREAM TEAM XTR ALLROUND

Thanks to its extreme effectiveness and relative simplicity, pole fishing attracts increasing numbers of anglers, even in the marine environment, who are often concerned about the cost of the rod.

With this excellent and robust pole, Trabucco want to cancel any doubt, proposing to a very accessible price a rod which is long enough to face the fishing in canal, river or lake to experience the first feelings without engaging in a competition. The safety of the structure in High Resistance Carbon is out of question, as no fish is able to put it into crisis. The telescopic top can be cut as wished to fit the diameter of the elastic, or eliminated by applying the bush directly on the second section. The rod is supplied with an extra kit of three sections, identical to those included in the rod; additional 3 section's kits can then be purchased separately.

### POLE PACK

- Dream Team XTR Allround 9.50 m
- Kit 3 Match (3,20 m)

Code	Description	Length	Ø	C. Length	Wt	Sections
131-87-950	Dream Team XTR Allround	9.50	43	155	780	7
131-87-960	Dream Team XTR Match Top 3	3.20	-	127	80	3

## XPS ELASTICS



XPS POWER CORE  
HOLLOW LATEX

XPS FLUORO LATEX

Within Trabucco XPS range you can easily find the proper elastic for the most stressful fishing style, with hollow, solid or double models

Find out more on page 312

## NEW DREAM TEAM XTR POWER CARP

### STRIPPA SYSTEM

Pole featuring remarkable power and exceptional balance, whose structure is completely put over, including the top section that offers a wide top bore of 4 mm.

Designed for commercial carp job, it fits the Strippa System, a SiC lined hole which enables to extract the elastic during the fish fight, actually adjusting the tension as needed to bring the fish to the landing net. Made from High Resistance carbon, it's finished with a special ultra-smooth paint which makes it pleasant to use and prevents

it from sticking to the hands when the rod is not dry. The Power Carp is supplied with an extra kit of two sections, also prepared with the Strippa System, while further kits of 2 or 3 sections can be purchased separately.

Code	Description	Length	Ø	C. Length	Wt	Sections
131-86-800	DT XTR Power Carp	8.00	40	140	817	6

#### POLE PACK

- Dream Team XTR Power Carp 8.00 m
- Kit 2 Carp (2,60 m)

#### STRIPPA SYSTEM



In the bottom area of second section you find a 4 mm wide hole, SiC lined for total protection, that enables to adjust the elastic tension during the fight.

## NEW DREAM TEAM XTR MARGIN CARP

### STRIPPA SYSTEM

Specially developed for commercial close-in fishing, which of course meets his peak during summer months when carp patrol the bank's step to look for food.

The High Resistance carbon blank can face the toughest battle, even though the chance to drive the elastic through the dedicated door (XTR Strippa on section nr. 2, now larger than ever with 4 mm width) reduces the stress on the pole because most of the fight is run with rod tip in line with the rig. Nothing to do with those standard commercial "speedy" poles, which aren't speedy at all because the pressure on fish is so high to cause panic, with longer fight time and growing

chances to miss a few fish. Easy to clean, the rod's surface has been slide finished (Trabucco A.S.E.F.) to smoothly run forth and back by hundreds of times. The XTR Margin Carp has all sections put-over, including top with 4 mm bore, and is supplied with an extra 2 section's kit (2,60 m), exactly same as the top two sections of the pole. Further kits of 2 or 3 sections - all fitting Strippa System - can be bought separately.

#### POLE PACK

Code	Description	Length	Ø	C. Length	Wt	Sections
131-86-700	DT XTR Margin Carp	6.00	33	160	430	4
131-86-710	DT XTR Margin & Power Carp Top 2	2.60	-	128	70	2
131-86-720	DT XTR Margin & Power Carp Top 3	3.80	-	135	155	3

- Dream Team XTR Margin Carp 6.00 m
- Kit 2 Carp (2,60 m)

## NEW DEMON POLE

Developed to fight with any particularly strong fish, which may submit the pole to extreme pulls, this series is available in three lengths to enable the user to get a tailor made rod, according to the personal fishing style and the environments that he usually attends.

The strong carbon and fiberglass composite is completely put over, except for the top, to allow fishing even close in, during the summer season. The tubular top section can be chopped down to adapt it to different size elastics of different diameter, but it can also be completely removed in case a particularly powerful elastic should be needed.

Code	Description	Length	Ø	C. Length	Wt	Sections
131-90-600	Demon Put Over Pole 6.0	6.00	35	115	430	6
131-90-700	Demon Put Over Pole 7.0	7.00	37	115	630	7
131-90-800	Demon Put Over Pole 8.0	8.00	40	115	830	8







**X  
JOINT**

It's well known that all joints connecting rod's sections are weak points, both from strength and action's point of view, as they cause those "dead spots" which are risky in term of breakage, beyond the bad looking. The solution is hidden in the X-JOINT technology, which means that - on joints area - carbon cloths are laid by 45° angle instead of 90°.

- Perfect curve, without dead spots.
  - Unique coexistence of flexibility and stiffness
  - Higher structural strength, because stress is dispersed through the blank, instead of being concentrated on joint's ends.
  - Less oscillations at the end of casting, which means quicker re-alignment of guides.
- Within X-Joint by Trabucco, the carbon cloth is wound by two directions, and such construction is visible on top end of each section.

**LRC CX2**  
LOW RESIN CARBON  
CONTENT NANO-TEK

It's the most sophisticated material employed in the production of Trabucco rods: a super high modulus carbon, whose layers are carefully assembled with exclusive nano-technological resins to obtain extremely light, compact, resistant sheets which are able to provide a sharp reaction in front of any sort of strain. Its proven strength enables our engineers to even use it in the most advanced surf casting rods.

**CX2**  
CARBON  
NANO-TEK

High modulus carbon material, located very close to the fantastic LRC-CX2 in the list of high grade materials. Since the resin distribution is less dramatic, it's possible to combine it with lower modulus materials, to generate light and strong rods with size by size programmed action to face the most various fishing conditions.

**ANTI  
GRIP  
SECTIONS**

In the rods produced with the computer assistance, the joint's precision is so high that, when they are wet, it is possible to form the vacuum, resulting in very tight section's locking. The problem is prevented by creating thin air chambers through cross bands milled on the male side of each joint, and this is one of the new technology specifications that enrich Energia XR Pro.

**CX0**  
CARBON  
MICRO-PITCH

Before getting through the curing process, the carbon blanks are wound by a special tape, which is free from any elasticity to contrast the expansion of the metallic mandrel. In such way, the resins are well distributed within carbon layers. The narrower the tape's pitch, the lower the resin content, and consequently the rod's blank will be lighter and reactive, thus perfect to create high grade fishing rods.

**CX-1**  
CARBON

The super sharp actioned rods aren't needed in all fishing styles: for example, bolognese or telescopic poles differ from carp fishing or boat rods, where reaction times are slower and the stress is heavier and longer. That's why CX1 is so important, with its special balance between strength and lightness which, compared to Micro Pitch version, gives the rod a lower reactivity both during cast and strike.

**S.H.M.R.  
CARBON**

It is the most widely used material for medium range rods, because it's perfect to solve at the same time all problems linked to costs and performances. The final products are nice to handle and quite durable, even if called to face hard life on the water.

**HRC**  
HIGH RESISTANCE COMPOSITE

The high end technology is not purely concentrated on top of the range products, but also gives the best in case of intermediate ones, where price counts. Made from a blend of carbon and fiberglass, it finds place in all branches of sport fishing.

**POWER  
FIBRE**

A special fiberglass material, able to develop outstanding strength in front of extreme stress, but also to bear the inevitable abuse due to inexperienced handling. This is the perfect material for rods destined to occasional or novice anglers.

**HVE**  
HIGH VOLUME EPOXY-FIBER

Based on fiberglass, this material shows layers linked by an advanced system of epoxy resins. As a consequence, its structure is extremely compact, and generate tubular blanks which are particularly strong and durable.

**CROSS  
WINDING**

The rod's blank is carefully wound by a carbon yarn braiding, which contrasts the ovalization under stress. As a consequence, the tubular is far stronger and, at the same time, the whole rod is definitely sharper. Both results are achieved without any sensible weight increase.

**CROSSED  
REINFORCED**

When a rod is designed to face extreme stress and maybe some shocks, its joints need to be adequately protected to last long time. We solve this problem with High Resistance carbon bands, applied orthogonally to longitudinal fibers

**high  
precision  
control**

Within any telescopic rods, the joint's precision is quite important to grant absence of play, not only to avoid noise, but mainly for a complete power transfer. For this reason, Trabucco rods are produced under the computer assistance.

**Zero  
Friction  
Blank**

A special finish of blank's surface repels water droplets which inevitably wet the rod, both during rainy or sunny days. This prevents line from sticking to the blank, an inconvenience which heavily affects casting distances, specially with light rigs.

*In the today's global market, the raw materials and components for rod's production are available to everybody, but is the technology that makes a difference. In other words, the way to handle the materials varies from company to company, leading to different results. Our core technologies are here illustrated and identified by icons that are used within the catalogue pages.*



**SS SUPER SLIM BLANK**

In some segments of sport fishing, the super slim profiled rods are very much appreciated for their natural lightness and for easy handling. In order to give these rods the required level of strength, Trabucco employs the most advanced production's technologies.



The taper of the blank provides balance and the right power to cast and drive the fighting fish to the landing net. Some special Trabucco rods show faster taper than the average, in order to develop a certain behaviour while in action.

**SUPER PROGRESSIVE JOINT**

In all sort of fishing rods, both telescopic and put over, joints are the most critical areas. Our own joints sweetly follow the rod's action, avoiding those "flat spots" which cause bend imperfections and seriously prejudice rod's strength.

**X Power Joint**

This technology gives strength to the rod's joints, but without exceeding in weight. This is possible because it takes advantage from high modulus carbon used to create crossed reinforcements, which bear the stress peaks in those areas.

**MULTI LENGTH SYSTEM**

In the river trout telescopic rods, as well as in some sea boat rods, the length is adjustable thanks to special rubber collars, which are fixed on top of sections to lock them to the below one. This is a careful job, done with hand craft precision.

**2 FLEX XTIP 3 FLEX XTIP**

The great sensitivity and the resistance to traction of the interchangeable fiberglass tips are important assets to influence boat rod's performance. The small single leg guides are well aligned and then carefully wrapped.

**TIP TIP**

In the segment of sea boat rods, this icon marks the models which aren't supplied with interchangeable tips, but only have a solid fiberglass telescopic tip. No difference regarding sensitivity and durability.

**SENSI TOUCH**

A fantastic sensation of smoothness and a greater control of the rod comes from the special finish of carbon rod handles. Apart from improving the fishing pleasure, this finish helps rod's cleaning after each fishing session.



The advanced high modulus carbon sheet, which gives enormous power to the rod's blank, sweetly blends into softer materials to provide the right sensitivity to detect fish bites. But the conversion is gradual, within the tubular top section, and this requires high class technology to avoid weak points and curve imperfections, which would cause poor looking but also a bad power transfer, with some risks of sudden breakage for the structure. All over the world, this concept is well known as "multi-action tip", but it's not equally common the process of layer's overlapping and fusion which bring to a perfect result, inch by inch. The technology which leads to the perfection of final product can give the best only in case the engineering and design process are assisted by computer, which can evaluate the stress point by point and realistically simulate the reaction of the material according to the fixed specifications.



The concept behind the Hybrid Tip arises from the need to obtain a good tip action on all models in our surf casting range, in order to compare the performance between the lower and the higher level rods. We then managed to get the unsurpassed sensitivity of a solid carbon tip design matching perfectly with the power of a tubular carbon blank, whatever the modulus of the carbon used to build the rod itself. With this hybrid solution, the blank takes care of the part inherent to the casting action, charging power before releasing it during the lash, while the tip takes care of directionality, of the accuracy and, obviously, of the identification of even the lightest fish bites at very long range. The crucial part is obviously the transition between the tubular carbon blank and the solid tip, subject where we have applied all our famous design capabilities.

# TELESCOPIC WHIPS

*It's the simplest and oldest type of fishing rod, faithful companion in the early experiences and strong ally in the competitions, which has no limits of use from fresh to salt waters, in Italy and around the world. Despite everybody talk about pole as first lady of match fishing scene, the humble whip brought to Gianluigi Sorti another World title, confirming its consistent actuality and its extreme effectiveness. But it is thanks to the Trabucco's creativity and technology that today we witness an evolution, because the exclusive Energhia Pro XR is no longer a normal whip, but a tool that comes out of the tradition to offer a lot more and be talked about itself as never before.*



Gianluigi Sorti



Goran Radovic

## ENERGHIA 2K EXTREME



Brand new series of telepole rods built in CX-2 super high modulus carbon, designed for high level competition. The blank of these rods is incredibly slim (we mean REALLY slim: 22.7 mm for the 8 meters model) and highly performing, while the tip section is tubular and not spliced. The blank is perfectly balanced, and it is possible to fish for hours without any problem. We do believe to have achieved the best production possible with the technology available nowadays.

Code	Size	C.Length	Wt	Sections
134-31-800	8.00	128	275	8
134-31-900	9.00	128	350	9
134-31-990	10.00	128	420	10



## NEW ENERGHIA XR PRO POLE

SENSI TOUCH  
CX2 CARBON NANO-TEK

Beautiful whips displaying lots of genuine versatility: they can switch from bleak fishing to more challenging fights with stunning ease. The reaction to impulse is quite fast, but under load the rod bends harmoniously, allowing the use of thin hooklinks in case of need. It's a merit of Trabucco X-Joint technology, which improves the joint's construction to give them an extraordinary flexibility: the rod draws an impeccable action curve, is stronger than the norm and the residual oscillations at the end of the cast are quite limited. At the base of the male joints, a special band milling prevents formation of vacuum in presence of humidity, avoiding the section's accidental locking. Each rod is supplied with a special rolling connector, which can be applied to the tip to ease the line's link; the body of the device rotates freely around its axis, actually dropping the risk

of line overlapping on tip section. Finally, a practical Velcro band allows to fix the winder to butt section, when carrying it with the rig already fitted.

Code	Size	C.Length	Wt	Sections
134-36-600	6.00	129	150	6
134-36-700	7.00	129	210	7
134-36-800	8.00	129	270	8
134-36-900	9.00	129	360	9

## FEATURES



It's well known that all joints connecting rod's sections are weak points, both from strength and action's point of view, as they cause those "dead spots" which are risky in term of breakage, beyond the bad looking. The solution is hidden in the X-JOINT technology, which means that - on joints area - carbon cloths are laid by 45° angle instead of 90°.

### TRADITIONAL REINFORCEMENT



- Stress is concentrated at both ends
- Dead spots, risk of breakage

### 45° REINFORCEMENT (X-JOINT)



- Stress is dispersed along the blank
- Perfect curve, no breakage risk

- Perfect curve, without dead spots.
  - Unique coexistence of flexibility and stiffness
  - Higher structural strength, because stress is dispersed through the blank, instead of being concentrated on joint's ends.
  - Less oscillations at the end of casting, which means quicker re-alignment of guides.
- Within X-Joint by Trabucco, the carbon cloth is wound by two directions, and such construction is visible on top end of each section.

### 0° UNI-DIRECTIONAL CARBON

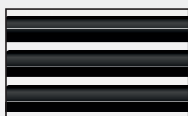

The carbon fibers oriented along the longitudinal rod's axis (0° unidirectional carbon) provide great resistance to linear traction.

### 90° SCRIM CARBON



The carbon fibers oriented at 90° to longitudinal rod's axis enable the cross section to resist the compression caused by strong flexion.

### X-JOINT ± 45° CARBON TECHNOLOGY



The X-Joint carbon fibers, oriented at ±45° to rod's axis, are able to absorb and disperse the torque, improving the joint's performance and saving the rest of the section.



ANTI GRIP SECTIONS

In the rods produced with the computer assistance, the joint's precision is so high that, when they are wet, it is possible to form the vacuum, resulting in very tight section's locking. The problem is prevented by creating thin air chambers through cross bands milled on the male side of each joint, and this is one of the new technology specifications that enrich Energhia XR Pro.

### THE FANTASTIC ROLLING CONNECTOR

Each Energhia Pro XR rod comes with a special line connector, to be glued on top tip, that eliminates line tangles thanks to a rotating device, similar to a microscopic swivel, which is connected to a string that ends with a slight head. The weight of such connector is absolutely irrelevant, but its benefits can be immediately seen.

The swivelling connector enables to link the rig without tangle risk.

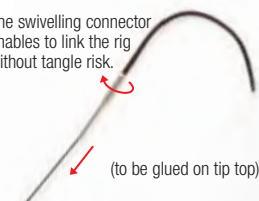

### THE VELCRO BAND



A light Velcro band, supplied with the rod, enables to fix the rig's winder to the butt, when it's stored in the holdall with the rig on.

### HOW TO CONNECT THE RIG LINE

1. Make two loops on top of the rig line; one large, the other fairly small.
2. Wrap the main loop around the tip string and tighten it.
3. To remove the rig, simply pull the small loop and it will be released.

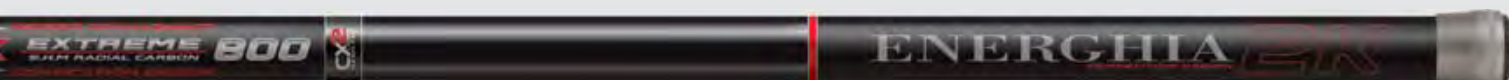
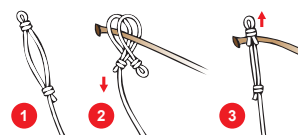



## ASTORE TX POLE

**CW** CROSS WINDING    **SENSI TOUCH**    **SS** SUPER SLIM BLANK    **CX2** CARBON NANO-TEK



In the design stage we identified the target to be pursued: the best competition pole rod. Every single element, every detail has been studied and revised only in order to get what for us is perfection: the Astore TX Pole. The blank has been built with the purest super high modulus carbon, light, reliable, essential in its dynamic elasticity. The fibers were then distributed on the mandrels according to a radial pattern so that the rod could respond safely to any type of torsion and bending. Butt section is long, a prerequisite for having an absolutely perfect balance. The tip has been built in combination with a solid carbon final part to allow maximum strike speed and to better manage the smallest monofilaments, resulting in a fast tip action and the best possible bending curve. Designed by agonists for agonists, it can not avoid to let every angler open-mouthed.

Code	Size	C.Length	Wt	Sections
134-21-500	5.00	130	160	5
134-21-600	6.00	130	220	6
134-21-700	7.00	130	270	7
134-21-800	8.00	130	365	8
134-21-900	9.00	130	490	9



## NEW DREAM TEAM XPS ALBORELLA

**SENSI TOUCH**    **SS** SUPER SLIM BLANK    **CX2** CARBON NANO-TEK



Dream Team XPS Alborella series is also available as set of 5 rods. In order to protect it during transport, the set is supplied with a padded holdall, which can contain a spare series of rods.

The bleak's population grows all over Italy, with specimens that easily exceed 50 grams of weight. More than ever, it's important to have rods that can deal with small and big bleaks during the same match, which is why we developed the Dream Team with particular enthusiasm and attention to details. The action is fast, with the sensitive tip free from oscillations when lifting the fish. The top cap, made from soft EVA, has a longitudinal groove to let the line pass, when the rod is transported with rig on. The rods are available individually, but also in set with the holdall, which contains five rods but has ten spaces to allow the user to store a double series.

The top cap, made from soft EVA, has a longitudinal groove to let the line pass, when the rod is transported with rig on. The rods are available individually, but also in set with the holdall, which contains five rods but has ten spaces to allow the user to store a double series.

Code	Size
134-13-000	Set 2.50m-3.00m-3.50m-4.00m-4.50m

Code	Size	C.Length	Wt	Sections
134-13-250	2.50	120	60	3
134-13-300	3.00	120	90	4
134-13-350	3.50	120	110	4
134-13-400	4.00	120	135	5
134-13-450	4.50	120	165	5



Gianluigi Sorti



## ASTORE NRG POLE

SENSI TOUCH CX2 CARBON NANO-TEK



3 model series, from 7 to 9 meters, very well balanced and stiff. They have been developed to be used in a number of fishing situations, including competition, and are built in S.H.M. carbon to enhance resistance and lightness, never enough when you come fishing with 8 or 9 meters pole. The slim blank allow a superior handling and better fishing experience, both in fresh and salt water.

Code	Size	C.Length	Wt	Sections
134-23-700	7.00	140	320	7
134-23-800	8.00	140	400	8
134-23-900	9.00	140	500	9

## ATOMIC XS POLE

CW CROSS WINDING SENSI TOUCH CX-1 CARBON



It's the natural sister of Atomic bolos: nice but aggressive, very aggressive when it's time to show the muscles. And it's dressed in line with them, with a young cosmetic which should recall that Trabucco's know-how can

reproduce the same reliability and strength of bolo also in a telescopic pole. As a matter of fact, these Atomic XS poles are suitable for mullet fishing, like declared on the butt section, a mission which is possible only when the best technology is employed, as done here with CX1 carbon and Cross Winding carbon yarn reinforcement. Those who have experienced the rod being pulled from hands, maybe in a fast running river, know that strength is vital in this sort of poles, and that the freedom to use thicker line than usual - being sure that the rod will cooperate - is worth because brings more fish to the landing net.

Code	Size	C.Length	Wt	Sections
134-24-700	7.00	140	320	6
134-24-800	8.00	140	400	7
134-24-900	9.00	140	500	8





**NEW** TITAN TLS EXTREME



Rods extremely strong but also easy to handle, a result obtained by working on multiple fronts. First of all, the blanks made from CX-1 High Modulus carbon, lightweight and reactive but not fragile at all, which is wrapped by a carbon yarn to absorb both the loads resulting from fishing action and accidental shocks. Then the handle finish, coated by a rubber paint that improves the comfort of use (Sensi Touch). Top section is tubular, a solution highly appreciated in sea fishing, and it carries the same rolling connector of Energhia Pro XR, which prevents the line tangling around the tip. A touch of elegance and functionality that brings the Titan to an unexpected level of quality.

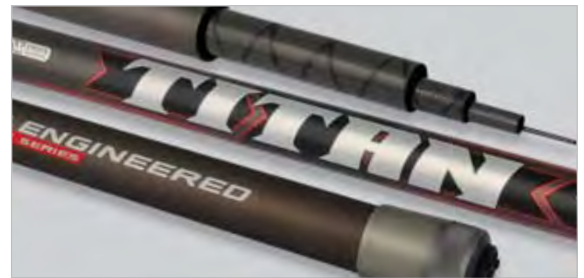

Code	Size	C.Length	Wt	Sections
134-27-500	5.00	124	195	5
134-27-600	6.00	124	280	6
134-27-700	7.00	124	380	7
134-27-800	8.00	124	490	8
134-27-900	9.00	124	620	9

SELEKTOR TLS POWER



Among the Trabucco telescopic poles, this is the most powerful one, with the high resistance SHMR carbon providing the power needed to stop the first run of any big fish, plus the crossed carbon bands protecting joints. The long, tubular top section displays a nice action, which is well followed by second section to care for the hooklink when the rod is almost vertical to let landing net come into play. But the Selektor TLS stands also for the short closed length, a good specification for a rod which could be permanently stored in the car's boot, along with a couple of rigs to be ready in case of fish. All inner sections are nicely painted in satin black, just because even the rods destined to tough life should carry a touch of Italian taste.



Code	Size	C.Length	Wt	Sections
134-29-600	6	120	280	6
134-29-700	7	120	400	7
134-29-800	8	120	480	8

## ACTIVA STX POLE



Stiff enough to show powerful fish who is the leader, but also light to be used till sunset without stress. On the river, at lake or seaside, Activa STX is a reliable partner, reactive and enjoyable to extend the fishing pleasure. Everything lives in its blank: built from CX1 high modulus carbon, then wrapped by a carbon yarn reinforcement which contrast its deformations, not only to prevent breakages, but also to improve its sharpness. In fact, such braiding is missing on top and second section, so that those sections are free to display their perfect action curve. The exclusive Sensi Touch handle finish is a really nice feature, practically a

signature which identifies many good Trabucco rods.

Code	Size	C.Length	Wt	Sections
134-34-500	5	135	215	5
134-34-600	6	135	275	6
134-34-700	7	135	370	7
134-34-800	8	135	485	8
134-34-900	9	135	570	9

## NEW ACTIVA XS POLE



One of the most successful series in the history of telescopic whips signed by Trabucco, today gets a new dressing with attractive graphics. The slim handle diameters and the total reliability of blanks are still the same, to continue to live strong experiences both in fresh and saltwater. Confirmed the structure in High Strength SHMR carbon, a material which differs from High Modulus for its properties to bear almost everything. The section's joints are further reinforced

by carbon crossed bands; the top section is tubular and the handle grip is finished with non-slipping rubber paint.

Code	Size	C.Length	Wt	Sections
134-32-500	5.00	113	210	5
134-32-600	6.00	113	270	6
134-32-700	7.00	113	360	7



## AMI XPS

When the hook is fixed at the end of a telescopic rig, it's certainly destined to hard life, because it cannot get protection from the elastic – as it happens in case of pole fishing – and doesn't benefit from reel's drag assistance, as normally occur in all the other fishing styles.

The striking power arrives directly and, when line gets to maximum tension, the hook receives 100% of load. That's why the steel quality is so important, because the property to absorb the stress, always recovering the original shape, it's a vital condition to provide efficiency and durability.

All XPS series are particularly brilliant in this sense, due to the high quality of materials used in their production process.



Find out more on page 226



## ACTIVA POLE



Series of whips particularly easy to transport because are compact and when closed they are really short. The low diameter blank together with a perfect balance make these rods extremely good and similar to more expensive ones, and they are offered at a nice price.



Code	Size	C.Length	Wt	Sections
134-33-500	5.00	113	209	5
134-33-600	6.00	113	272	6
134-33-700	7.00	113	366	7



## ERION X-LIGHT POLE



The former Erion TLS, built from High Modulus carbon material, now grows and gets specialized in two different versions: X-Light and X-Power, answering from one side the demand of lightness coming by the finest anglers, and from the other side the need of power in front of big river and sea fish. Thanks to the particularly fine handles (Super Slim Blank), this X-Light series is quite handy yet well balanced. Its tubular top is designed to also deal with light floats and fine hooklinks. Sensi Touch handle is obtained from a satin coating which doubles the fishing pleasure.

Code	Size	C.Length	Wt	Sections
134-15-400	4.00	130	110	4
134-15-500	5.00	130	180	5
134-15-600	6.00	130	250	6
134-15-700	7.00	130	315	7



## ERION X-PWR POLE



It's the bad sister of Erion X-Light, able to drive the most powerful fish to landing net, thanks to its blank's construction, designed with fast tapered profile. The high level of reliability also comes from the High Resistance carbon joint's reinforcements, which has been applied to contrast dangerous deformations thus grant them a longer life. The tubular top section is a must on rods, like this, which are destined to tough life due to big and restless river fish, as well as to the speed of sea fish like mullet and sea bream. The handle grip is coated with a special satin finish (Sensi Touch).

Code	Size	C.Length	Wt	Sections
134-28-500	5.00	130	230	5
134-28-600	6.00	130	340	6
134-28-700	7.00	130	450	7





Maurizio Fedeli



## XPS POWER PLUS & XPS MATCH PRO



In spite of the apparent simplicity, the rigs destined to telescopic poles have their own problems. Talking about main line, an high abrasion resistant line is always recommended, as it should survive the compression caused by lead shots and the excess heat due to their movement along the line. No problem for XPS Match Pro, whose polymer include ceramic components which harden the surface and keep low temperature. The hooklink's worst enemies are knots, both on hook's spade and connection to mainline. Therefore, the right solution is called XPS Power Plus, as its balanced elasticity avoids knot's coils damaging each other.

Find out more on page 205

## BOLO RODS

*From the early fifties to present times, the bolognese has brought around the world the image of Italy as a country with a strong sport fishing vocation. Everyone talks about it, everyone knows the technique, everyone appreciates the quality of Trabucco rods. From today, such certainty turns into astonishment, because Energhia bolo perform a substantial leap in the scale of quality, thanks to some interesting innovations that link tradition to the future. The construction of telescopic joints stands off the crowd, as they benefit from X-Joint technology to display the unique coexistence of fastness and flexibility.*

*A wonder that actually improves casting distance, because it shortens the oscillations, realigning the rings in a faster time at the end of the pushing effort. With Energhia XR, the traditional way of evaluation - which is normally done by shaking the rod - becomes even limiting, because only on the water you can appreciate the big difference compared to any other rod belonging to the "normal" world of high class bolognese.*

### NEW ENERGHIA XR PRO LIGHT

Within the Energhia XR family, the Pro Light plays a dual role. On one hand it solves the most difficult days allowing the use of fine hooklinks; on the other it is indispensable in short range or top water fishing with lightweight rig's shotted, one of the most exciting situations because a big fish plays its cards with a fast start to reach a safer area. In both cases, the hooklength is protected by the action softness of top three sections,

perfectly cooperating with the rest of the blank thanks to the fantastic X-Joint. High leg Sea Guide SiC guides have the corrosion free frame, with a sliding guide on the second section to distribute stress. The slimness of the handle and the overall lightness of the rod make you dream memorable fishing days.



### NEW ENERGHIA XR COMPETITION

It is versatile as a top match angler should be, with the ability to perform a mixed bag fishing at medium distance, but also to quickly adapt to the sudden pull of a bonus fish which must absolutely be landed. This behaviour is typical of the highest grade rods, designed by those who have decades of experience, and comes from the structure of the CX2 high modulus carbon blanks, a special material with nanometric diffusion of the

resins between different layers, that work perfectly to develop a very fast action. The fine long leg guide's configuration, with Sea Guide SiC guides which can quickly dissipate heat, is really protecting the line from premature aging. The presence of an eight meters rod within the series is important to tackle considerably deep rivers.



### NEW ENERGHIA XR ALLROUND

Series characterized by extremely reactive blanks, able to contrast Barbel and Carp runs, but even the strongest sea fish with a reliable structure based on CX2 high modulus carbon. At first check, these rods immediately give a feeling of great power, but under stress they display a round curve, due to the X-Joint technology which has completely changed the parameters of quality with an unexpectedly sweet action. Until

yesterday, an extreme cast was only possible with stiff rods which then turned out to be unable to manage the fish reaction; today, we have the Energhia XR Allround that solve both problems with a certain mastery. The components are at the top, with SiC Sea Guide's quality and reel seat made from stainless steel. This series include an eight meter rod that can surprise anyone.



# ENERGIA XR



FEATURES:



Code	Length	C. Length	Weight	Sections	Guides
121-00-500	5.00	135	140	5	SiC
121-00-600	6.00	135	180	6	SiC
121-00-700	7.00	136	250	7	SiC



Code	Length	C. Length	Weight	Sections	Guides
121-01-500	5.00	138	160	5	SiC
121-01-600	6.00	141	210	6	SiC
121-01-700	7.00	141	290	7	SiC
121-01-800	8.00	142	360	8	SiC



Code	Length	C. Length	Weight	Sections	Guides
121-02-500	5.00	137	180	5	SiC
121-02-600	6.00	139	260	6	SiC
121-02-700	7.00	141	340	7	SiC
121-02-800	8.00	142	430	8	SiC



Thanks to the use of multi-axial carbon sheets, the X-Joint allow to obtain perfect action curves, absorbing all the torsions to which the blank is subjected, increasing the structural resistance and the response to stresses. X-Joint is therefore able not only to improve the section's links, but rather assist the whole structure for maximum performance. Definitely the best joints ever made!

0° UNI-DIRECTIONAL CARBON

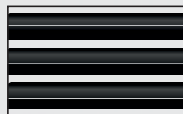

The carbon fibers oriented along the longitudinal rod's axis (0° unidirectional carbon) provide great resistance to linear traction.

90° SCRIM CARBON



The carbon fibers oriented at 90° to longitudinal rod's axis enable the cross section to resist the compression caused by strong flexion.

X-JOINT ± 45° CARBON TECHNOLOGY



The X-Joint carbon fibers, oriented at ±45° to rod's axis, are able to absorb and disperse the torque, improving the joint's performance and saving the rest of the section.



In the rods produced with the computer assistance, the joint's precision is so high that, when they are wet, it is possible to form the vacuum, resulting in very tight section's locking. The problem is prevented by creating thin air chambers through cross bands milled on the male side of each joint, and this is one of the new technology specifications that enrich Energia XR Pro.



REEL SEAT

The plate reel seat is the best you can actually ask for, the tried and tested PacBay. Made entirely of stainless steel with protective rubber profiles, it is resistant to wear and external agents, and is ergonomic and stylish at the same time.



**HI QUALITY GUIDES** The guides fitted on Energia XR rods take advantage from a special production process, referred to as PVD, English acronym of "Physical Vapor Deposition", which allows to obtain a very high resistance to corrosion and aggressive agents. All this takes place through the deposition of a protective film on the frame, which seals and protects the steel without changing its structure, weight and technical specifications. All accompanied by SiC rings. A further step forward for rods with very high performance and more reliable in every part!

# ENERGHIA 2KS



## ENERGHIA 2KS COMPETITION

**SS** SUPER SLIM BLANK    **SENSI TOUCH**    **CX2** CARBON NANO-TEK

The most glorious range of Trabucco bolognese grows again, thanks to the technological evolution but also thanks to endless progression of the most traditional Italian fishing style. So the Competition is here to shock everybody, with its amazing CX2 carbon material which has proven to be breakage free, thanks to the even dispersion of the nano-technological resin, deputed to seal the carbon layers. This project has taken into consideration the need to more and more use fine lines and small hooks, which require the right sweetness in the rod, without missing the reactivity. The series fits hi-leg SiC guides to avoid wet line sticking to the blank. Fantastic details are the satin finish of whole butt section and woven carbon reinforcement applied on to reel seat area.

Code	Length	C. Length	Weight	Sections	Guides
120-96-600	6.00	150	215	5	SiC
120-96-700	7.00	150	265	6	SiC

## CARATTERISTICHE TECNICHE:



Ultra-long leg guides with SiC ring, designed to avoid any contact between line and rod's blank.



Woven Carbon reinforcement in the handle area.



Size 6 plate reel seat, made from steel and featuring rubber foot to disperse pressure on the rod's handle.

## ENERGHIA 2KS ALLROUND

**SS** SUPER SLIM BLANK    **SENSI TOUCH**    **CX2** CARBON NANO-TEK

Developed along with Competition series, this one took Allround nickname to remark that it can escape from the perfect world of match fishing and spend a day on a fast river or at exciting sea side. Its body is stiffer than Competition's one, and also a big fish can quickly detect the difference, as it turns the head back to the bank where we are waiting with the camera. The sliding guide on second section plays an important role, because it can distribute the load and straighten the line during cast, adding metres to the reachable distance, specially during those rainy days. Also the Allround is fitted with long leg SiC guides to protect the line, specially when the terrible combination of tension and friction would inevitably push the temperature to a dangerous level.

Code	Length	C. Length	Weight	Sections	Guides
120-97-600	6.00	154	250	6	SiC
120-97-700	7.00	154	330	7	SiC



# ENERGHIA TXL



Maurizio Fedeli

## NEW ENERGHIA TXL PLUME

SS SUPER SLIM BLANK SENSITOUCH CX2 CARBON NANO-TEK

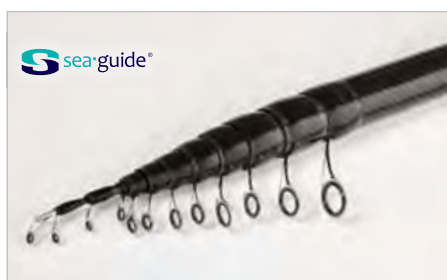

The sliding guides, applied on all intermediate sections, distribute the load very well through the blank, and keep the line away from rod's blank.

An important project, with relevant impact on rod's performance, has generated these great Bolognese series featuring sliding guides on all sections. Very well designed and hand crafted, those guides are wrapped on to light tubular carbon segments and are aimed at keeping the line away from the rod, easing the achievement of remarkable casting distances, even with light rigs and wet conditions. On top of that, such configuration distributes the loads along the section's wall, actually expanding the life of the line and of the rod itself. The Plume are optimally balanced, showing off a powerful body combined with a cushion zone in the upper part to deal with any fishing condition in fresh water or sea, also with relatively thin hooklinks. The Sea Guide SiC guides have the no-vibration "Y" design frame, protected against corrosion.

Code	Length	C. Length	Weight	Sections	Guides
120-90-600	6.00	158	230	5	SiC
120-90-700	7.00	165	300	6	SiC

## NEW ENERGHIA TXL POWER LIGHT

CW CROSS WINDING SS SUPER SLIM BLANK SENSITOUCH CX2 CARBON NANO-TEK



TXL Power Light is the perfect combination of lightness and strength, highlighted by the carbon bands reinforcement applied under Cross Winding process.

Apparently in contrast with each other, or even incompatible, the specifications of strength and lightness are beautifully married in this series of Bolognese rods carrying a name of great prestige. When holding Energhia you expect so much from it, knowing that you can even ask for the impossible, and, in case of TXL Powerlight, the answer is really of high profile. The structure made from High Modulus CX2 carbon is protected by a cross-wound bands of carbon that contrast the blank's deformation under stress, making it much more responsive and highly resistant both to traction and to accidental, side impacts. The Sea Guides SiC guides, with medium-long leg, are completely free from corrosion and have the "Y" frame design to ensure stability during the fight with any big fish.

Code	Length	C. Length	Weight	Sections	Guides
120-89-600	6.00	145	290	6	SiC
120-89-700	7.00	145	340	7	SiC

### FEATURES:



#### HI QUALITY GUIDES

The new TXL rods take advantage from latest stainless steel frame guides, featuring the PVD coating, actually the best solution in terms of corrosion resistance.



#### REEL SEAT

Size 6 plate reel seat, made from steel and featuring rubber foot to disperse pressure on the rod's handle.



Maurizio Fedeli

**NEW FRANGENTE** BOLO ALLROUND SW



Series destined to conquer an important place in the sea fishing field, where the Bolognese style has a deep tradition and a bright future. In an environment which is openly hostile to the whole equipment, the rod suffers aggression from salt in its metal parts, such as guide's frame and reel seat. Problem solved on Frangente thanks to Sea Guide, one of the world's top companies with a special attention to corrosion problems. These rods have a very consistent structure, further reinforced in the handle area by crossed carbon bands, while they display a tip action that allows you to delete the chance that

the toughest fish can find shelter on the bottom or in the margins. Nevertheless, these rods are distinguished by outstanding lightness and balance.

Code	Length	C. Length	Weight	Sections	Guides
121-05-600	6.00	131	275	6	SiC
121-05-700	7.00	131	340	7	SiC

**FEATURES:**



**REINFORCED HANDLE**

The handle is reinforced with Woven Carbon, just below the reel seat and in the near area, this to further raise reliability and precision in action.



**HI QUALITY GUIDES**

Special guides are wrapped on Frangente rods; they are able to resist saltwater corrosion much longer than any other guide in the market. The stainless steel frame is protected by the PVD coating, and fits SiC ring for top performance.



**REEL SEAT**

As well as for the guides, the Frangente has been equipped with a saltwater resistant reel seat, able to ensure maximum reliability during its life span. The ergonomic shape and rubber foot to better fit the rod's shape complete this essential component.

**TITAN BLS EXTREME**



The nice side of Bolognese rods is versatility, as a single one can solve thousands of fishing situations. With rods like these Titan Extreme, it's possible to move from classic float fishing in lake or river to trout fishing with just a lead sinker, or fish at sea with paste bait. The secret of this series is the fantastic balance, which makes every size – including the always tough 7 metres – easily usable with a single hand. This is due to the accurate project, based on CX1 carbon reinforced by Cross Winding, which

enable to cast up to a 20 grams float without problems and with no oscillations. Guides are quite good, with medium leg "Y" frame and SiC ring, as well as the size 6 wrapped plate reel seat.

Code	Length	C. Length	Weight	Sections	Guides
122-61-500	5.00	130	235	5	SiC
122-61-600	6.00	130	325	6	SiC
122-61-700	7.00	132	435	7	SiC

**EPICA BSR BOLO**



Even though the industry is continuously looking for new solutions to produce pleasant and performing rods, it's not so common to meet something really new and interesting. Once again, Trabucco gives us this opportunity, with this new series of good bolos, featuring an innovative reel seat. It's called Super Light Integrated Reel Seat, and it works like a normal size 6 plate reel seat, but it's not fixed by standard wrappings. In fact, it's integrated in a graphite support, which is glued directly to rod's handle, resulting less bulky and much more stable than a wrapped, plate reel

seat. The rod is a strong bolo made from SHMR carbon, nicely wrapped with SiC long leg guides. The whole blank is finished by a black satin coat, which is actually waterproof, so that it helps casting longer because wet line doesn't stick to the rod's surface.

Code	Length	C. Length	Weight	Sections	Guides
120-28-500	5.00	135	230	5	S-SiC
120-28-600	6.00	135	300	6	S-SiC





FEATURES:



Medium leg guides with "Y" shape frame.

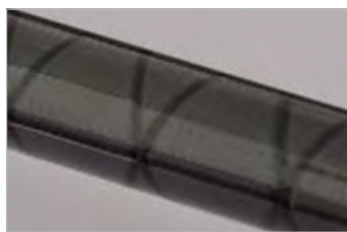

Carbon yarn reinforcement wrapping (Cross Winding).



Plate reel seat size 6 made from steel and rubber.



FEATURES:



The fantastic plate reel seat is integrated in the handle, without any wrapping.



Long leg guides with SIC ring.



Aluminium butt cap with rubber insert.





# ATOMIC

EXPERIENCE, POWER,  
CONTROL



## ATOMIC XS COMPETITION

In Italy, as well as in the rest of Europe, Atomic has become synonymous of tremendous power and strength, thanks to outstanding rod performances, not thanks to advertising! Within the new range, this Competition series is the access door to the Atomic world, a sort of link to the most powerful ones, which are identified by growing numbers like 2, 4

and 6. Its structure is fast tapered, with a compact closed length and a reasonably fine top area, which allow a certain casting precision and tolerate the use of relatively fine hooklinks (not less than 0,14 mm). The medium leg SiC guides have a vibration-free "Y" shape frame, while the plate reel seat is wide enough to accept big size reels (size 7).



## NEW ATOMIC XS ENERGY

The three powerful models that make up the Atomic XS Energy series benefit of a production technology that involves the use of carbon CX-1, strengthened in those areas subjected to greater stress. These very powerful rods lend themselves to be used in the most demanding conditions you face in fresh or salt waters. With them you can cast

rigs ranging from 4 to 60 grams and lift fish in excess of 1 kilo weight, without the use of landing net. Despite this, Atomic XS Energy bolos are balanced and pleasant to use. They are equipped with high quality components: SiC guides, PacBay plate reel seat and non-slip grip.





- X6 ■
- X4 ■
- X2 ■
- ENERGY ■
- COMPETITION ■

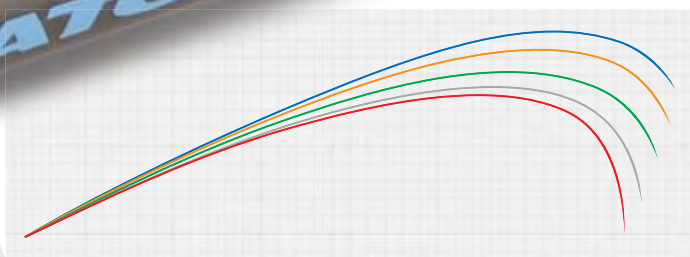

Model	Max Load	Casting
X6 FORMULA	6.0kg	100g
X4 FORMULA	4.0kg	80g
X2 FORMULA	2.0kg +	60g
XS ENERGY	2.0kg	60g
XS COMPETITION	1.5kg	30g

Atomic actions. Each one of these rods is designed to target a certain job. In fact, when loaded by same test weight, the five series react in a different way, confirming that they have been built to develop a specific power range.

Since ever, Atomic by Trabucco means power for long range casting and strength to successfully drive big fish to the landing net. But such tremendous power is not without control, as each single action has been engineered with accurate target, according to Trabucco's experience. Select your own Atomic and bring it to the water: fish will immediately realize who is the leader!

FEATURES:



"Y" frame SiC guides. All guides feature SiC ring to provide maximum protection to the line and dissipate heat developed during fish fight. The frame arms join together before forming the guide's foot, thus offering extreme stiffness and stop vibrations.



Pacific Bay reel seat. The plate reel seat is made from stainless steel, featuring protections for reel's foot and rubber base. Size 7 to accept big sized reels.

Aluminium butt cap and EVA tower. The nice cap, including a protective rubber insert, is made from aluminium to provide lightness and strength. In order to correctly space the guides when the rod is closed, an ultralight EVA tower has been added in the rod's butt.



Anti-grip joint's finish. The male side of all joints has been finely sanded with computer aided machine to obtain maximum precision. This prevents sticking when joints are wet, while at the same time it grants complete contact, avoiding any vibration.



Cross Winding carbon braiding. The whole blank of Atomic bolos, except top section, is wound by an high modulus carbon yarn protects it from accidental shocks. In addition, it contrasts the blank's deformation under heavy load, actually stiffening it.

SENSI TOUCH CX-1 CARBON

Code	Length	C.W.	C. Length	Weight	Sections	Guides
122-55-500	5.00	Max 30g	130	220	5	SiC
122-55-600	6.00	Max 30g	132	290	6	SiC
122-55-700	7.00	Max 30g	134	375	7	SiC



SENSI TOUCH CX-1 CARBON

Code	Length	C.W.	C. Length	Weight	Sections	Guides
122-53-500	5.00	Max 60g	128	232	5	SiC
122-53-600	6.00	Max 60g	130	318	6	SiC
122-53-700	7.00	Max 60g	132	427	7	SiC





Goran Radovic



Marco Busani

## ATOMIC X2 ALLROUND

Through the X2 you get into contact with the stunning power which gained the Atomic concept a leading position in the segment of powerful bolos. Capable to cast up to 60 grams rig and lift up to 2 kilos weight, these rods can shock all those who like the strong tractions and consequently check the tackle very well before buying any. The safety is ensured by the carbon cross winding, which binds the blank up to second section, just to leave the top some freedom to develop its action curve. A true



braiding - not to be confused with cosmetic finish - which contrasts the deformations when the rod is heavily loaded and disperse the stress along the blank. Quality components are certainly worth the addition, like Pac Bay plate reel seat (size 7) and SiC medium leg guides with "Y" shaped frame to avoid vibrations during retrieve.

## ATOMIC X4 FORMULA

A nice blend of strength and balance gives a certain appeal to these new rods, which are sitting in the middle of Atomic range. As a matter of fact, too many Bolognese belonging to "super power" class are perfect on casting ability, but actually show poor balance or difficult handling. With casting weight up to 80 grams and able to lift up to 3 kilos, X4 rods can face the toughest conditions on the river, lake or at sea side without fear, thanks to the CX1 carbon construction, protected by cross carbon braiding. With hooklinks in the range of 0,20-0,25 mm diameter, these rods can really stop those endless runs and lift the fish from

water in case landing net could not be used. Guides are "Y" frame medium leg with SiC ring. Pac Bay reel seat of size 7 to accept big size reels.



Code	Length	C.W.	C. Length	Weight	Sections	Guides
122-58-500	5.00	Max 80g	140	290	5	SiC
122-58-600	6.00	Max 80g	142	415	6	SiC
122-58-700	7.00	Max 80g	144	520	7	SiC

## ATOMIC X6 FORMULA

If your favourite fishing condition is not suitable for the most powerful bolo available in the market, you certainly need an Atomic X6! Realistically, these rods can cast up to 100 grams rig and actually lift up to 6 kilos weight, but how many anglers could do so? For this reason, the series is made of 5 and 6 metres length only, as longer ones would have resulted out of control by the user. The rod can deal with sturdy hooklinks

around 0,25-0,30 mm in diameter and, exactly like the other X2 and X4, it can be used for light drifting because CX1 carbon wall is assisted by carbon yarn braiding from butt to second section.



Code	Length	C.W.	C. Length	Weight	Sections	Guides
122-59-500	5.00	Max 100g	142	335	5	SiC
122-59-600	6.00	Max 100g	146	445	6	SiC





Code	Length	C.W.	C. Length	Weight	Sections	Guides
122-57-500	5.00	Max 60g	129	235	5	SiC
122-57-600	6.00	Max 60g	131	320	6	SiC
122-57-700	7.00	Max 60g	133	410	7	SiC

FEATURES:



Guides fitted on top and second section are slightly oversized, to enable silicone stoppers pass through during sliding float's fishing.



Carbon yarn reinforcement wrapping (Cross Winding).



Reinforced top guides.



Gianluigi Sorti & Atomic Bolo  
World Champion 2015



# ACTIVA

## ACTIVA STX BOLO



The continuously evolving technology should not take care of high grade tackle only, but also bring the best possible performances to lower layers of the range and make them affordable to everybody. This nice Activa STX proves that Trabucco engineering team knows the job quite well, because the rods show pretty good balance and power, as well as extremely fine details: specifications which are normally confined to top of the range bolos. Compared to existing Activa Bolo, these new rods have been designed with faster taper and reinforced with a carbon spiral up to third section. As a

result, the body is remarkably stiff, and this has allowed the engineers to also include a good seven metres in the series.



Medium leg guides with "Y" shape frame.

Code	Length	C. Length	Weight	Sections	Guides
120-24-500	5.00	135	235	5	SiC
120-24-600	6.00	135	315	6	SiC
120-24-700	7.00	135	380	7	SiC

Carbon yarn reinforcement wrapping (Cross Winding)



## NEW ACTIVA XS BOLO



Series of Bolognese rods particularly easy to transport because are compact and when closed they are really short. The low diameter blank together with a perfect balance make these rods extremely good and similar to more expensive ones, and they are offered at a nice price. Butt with non-slip finish and equipped with SiC guides.

Code	Length	C. Length	Weight	Sections	Guides
120-32-500	5.00	121	220	5	SiC
120-32-600	6.00	123	280	6	SiC
120-32-700	7.00	125	360	7	SiC



Marco De Biase

## ARROW 2000 / 3000 / 4000

**XTRA TOUGH BODY**

**5.1:1 GEAR RATIO**

**SUPER LIGHT ALU**

**5+1 BB SYSTEM**

**GRAPHITE 1x SPARE SPOOL**

**OVERSIZED SPOOL DESIGN**

- Super stiff hi-tech graphite body
- Ultralight aluminium main spool
- Graphite spare spool
- Hollow bail with anti twist line roller
- Double shielded stainless steel ball bearings
- Power Fight aluminium handle

Find out more on page 166

# ERION

## ERION X-LIGHT BOLO

SS SUPER SLIM BLANK

SENSI TOUCH

CROSSED REINFORCED

high precision control

S.H.M.R. CARBON



It's the light sister of Erion XS Allround, capable to handle finer hooklinks with his balanced softness; with these rods, the most classic Bolognese style – fishing for chub and barbel in the clean, running waters of medium sized rivers – becomes a pleasant job offering exciting experiences. The medium leg guides, with "Y" shaped frame, can actually absorb vibrations during retrieve, limiting abrasion and heating which are the worst enemies for

the line. A line which lasts longer is definitely more reliable, and also helps reducing costs. The special satin finish of the handle is easy to clean and gives a special feeling during fishing.

Code	Length	C. Length	Wt.	Sections	Guides
120-27-400	4.00	132	145	4	S-SiC
120-27-500	5.00	134	225	5	S-SiC
120-27-600	6.00	136	295	6	S-SiC

## ERION XS BOLO ALLROUND

SENSI TOUCH

CROSSED REINFORCED

high precision control

S.H.M.R. CARBON



These new rods are particularly nice in every detail, as they have been finished with same care normally reserved to high grade models. Consequently, Erion XS impress for the interesting quality/price ratio, a specification which counts a lot in these days, as the general approach is to "enjoy without spending a fortune". A target which has nicely been hit by Trabucco's development team with this high grade carbon blanks, designed under Super Slim concept to offer balanced rods, reliable from structure's point of

view and performing in action. The sliding guide in the middle of second section is quite worth, as it helps distributing load and stress, as well as easing long casts with his specific ability to help line's flow.

Code	Length	C. Length	Wt.	Sections	Guides
122-11-500	5.00	140	255	5	S-SiC
122-11-600	6.00	140	380	6	S-SiC

## ERION X POWER BOLO

SENSI TOUCH

CROSSED REINFORCED

high precision control

S.H.M.R. CARBON



A very stiff body and a medium soft top area are the main specifications of the Erion Bolo Power action. The first one provides power to cast the float rig at distance and safely drive the big fish to the waiting landing net. The second one takes care of casting accuracy and strike's efficiency. Well programmed roles in a modern bolo, destined to face the lakes and river streams, where it can also easily catch trout, but even the sea rocks. The handle is tapered as much as needed to grant power and strength, without excess in diameters, and is brilliantly dressed by Sensi Touch finish: a fantastic sensation of smoothness and the chance to easily clean it at the end of a fishing

session. Guides are medium-long framed with "Y" shape to avoid vibrations.



Internal screw butt cap.

Code	Length	C. Length	Wt.	Sections	Guides
120-29-500	5.00	140	260	5	S-SiC
120-29-600	6.00	145	370	6	S-SiC



## REVENTON MASTER BOLO

**SENSI TOUCH** **CROSSED REINFORCED** **high precision control** **S.H.M.R. CARBON**



Soft rubber cushion plate reel seat.

Entering the world of fishing can actually scare any newcomer, but the role of leading companies like Trabucco is also to ease the tackle choice, showing the smoothest way to get the first emotions with reliable and handy rods, having a balanced quality/price ratio. With Reventon bolos, for example, fishing with float in canals and streams, but also facing commercial lakes or sea ports is a real pleasure. The High Resistance carbon structure can bear any strong cast and pulls, because it's assembled under computer control and well reinforced at joint areas. Guides and reel seat quality have been selected to provide total reliability.

Code	Length	C. Length	Weight	Sections	Guides
120-31-400	4.00	125	150	4	S-SiC
120-31-500	5.00	125	250	5	S-SiC

## SYNTIUM BOLO

**SENSI TOUCH** **CROSSED REINFORCED** **S.H.M.R. CARBON**



Rigid action rod with high speed hook setting. Constructed by a "Radial Carbon Technology" and the latest technologically innovative materials to guarantee satisfaction for the most demanding angler. Particularly suited for big fish with medium heavy line both in fresh water and the sea. This rod is not easy at the beginning, especially if you are fishing in deep waters and turbulent flows, but as soon as you take the hand becomes an invaluable ally to fish on that unreachable line... for others!

Code	Length	C. Length	Weight	Sections	Guides
120-18-500	5.00	126	229	5	SiC

## SYNTIUM NRG BOLO

**SENSI TOUCH** **CROSSED REINFORCED** **S.H.M.R. CARBON**



Series of stiff rods designed for river trout fishing and very good for salt water fishing as well, where traditionally rods of this kind are used to oppose the fast and powerful coastal fish runs. The blank is made from super high modulus radial carbon, reliable under conditions of high stress, strengthened by a technology called Crossed Reinforced. Short legged S-SiC guide allow an extra smooth sliding of the line.

Code	Length	C. Length	Weight	Sections	Guides
120-22-500	5.00	124	184	5	S-SiC

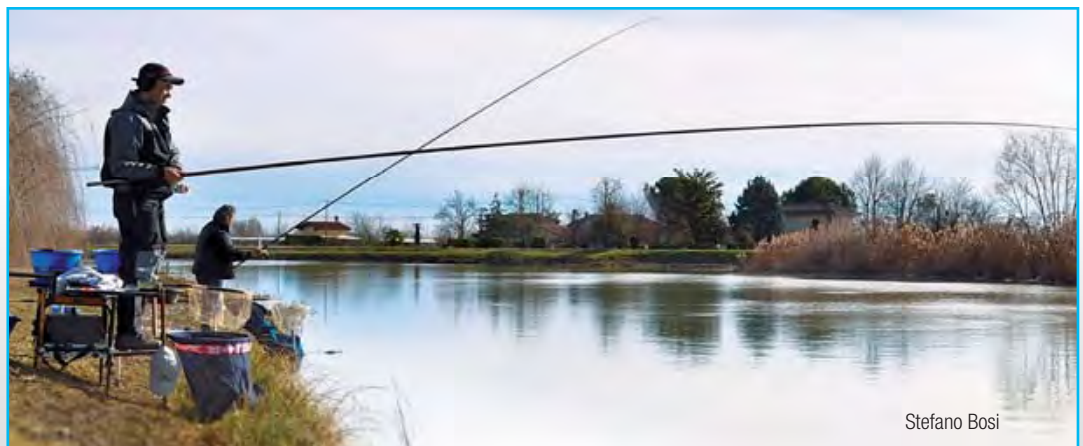

Stefano Bosi

**NEW** ATTRACTIVE MINI BOLO



Series born from a very clever and complicated project, which led to the creation of three rods having identical closed length, a feature which is not so common in the world of compact bolos. The presence of long rods, such as 4,50 and 5 meters, makes even more interesting this series, which is wrapped to perfection with lightweight long leg SiC guides. The section's taper has been designed to develop a fast action and, at the same time, obtain a truly short set of guides. All sections are finished with a special anti-stick paint, which eases the execution of long casts, even in presence of high humidity.



Code	Length	C. Length	Weight	Sections	Guides
124-82-400	4.00	70	150	8	SiC
124-82-450	4.50	70	190	9	SiC
124-82-500	5.00	70	230	10	SiC

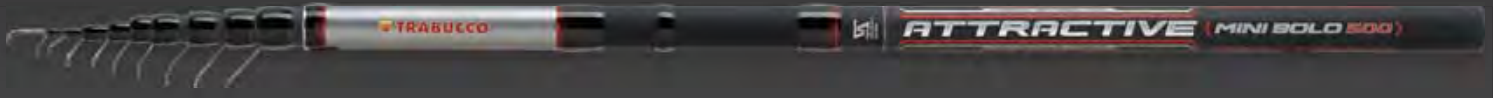

ERION XS MINI BOLO



Let's face it: a handy and compact rod, you can leave in the car and that is not only easy to use but first of all reliable, it is a rod that is interesting for everybody. So this is not a rod for specialists but a rod which finds its use in the stream as in the pond, river or at sea. The high resistance carbon is a guarantee of total reliability, forgiving the mistakes of beginners, but also guarantees lightness and precision. The ringing S-SiC quickly disperses the heat, and allows the safe use of even very thin monofilaments.

Code	Length	C. Length	Weight	Azione	Sections	Guides
124-83-320	3.20	63	120	MH	7	SiC
124-83-360	3.60	64	150	MH	8	SiC
124-83-400	4.00	66	190	MH	9	SiC
124-84-340	3.40	65	160	H	7	SiC
124-84-380	3.80	66	185	H	8	SiC

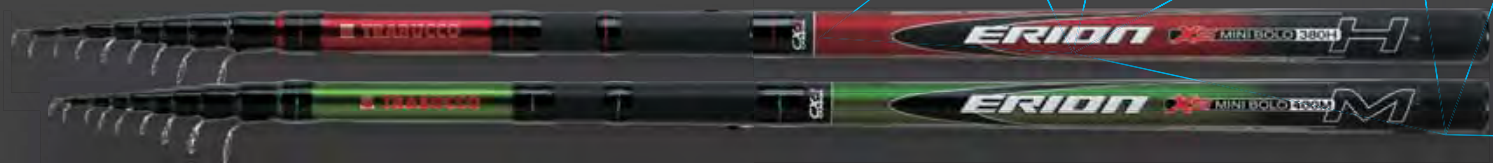

ANTRAX BLS STREAM



Compact and short elements Bolognese rod. It can be used in a number of situations thanks to their easy handling and reliability, really at the top. The high resistance carbon fibers make the blank not only lightweight but also strong enough to fight whatever fish will bite at your bait.

Code	Length	C. Length	Weight	Sections	Guides
124-80-380	3.80	104	175	5	S-SiC
124-80-450	4.50	108	230	6	S-SiC

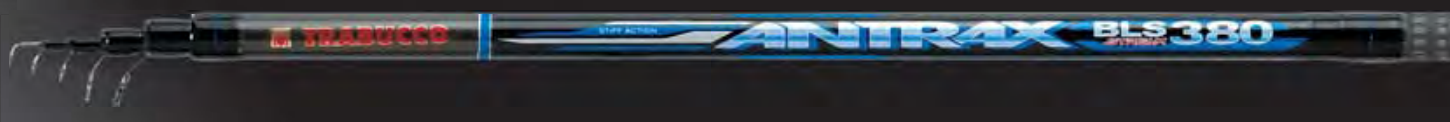

**NEW** SYNTIUM FX



These rods are made using a new procedure which allows the combination of H.R. Carbon and Powerfibre. Easy to transport, these rods can be used for trout fishing in reservoirs and streams, even with heavy rigs. The Syntium FX is really versatile and if necessary can be used as Bolognese when fishing for carp. All the rods are equipped with S-SiC guides and premium quality reel seat.

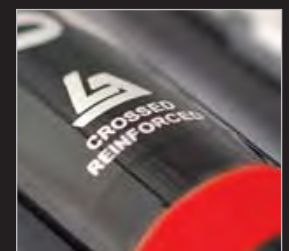

Code	Length	C. Length	Weight	Sections	Guides
124-81-300	3.00	72	145	5	S-SiC
124-81-350	3.50	74	195	6	S-SiC
124-81-400	4.00	77	245	7	S-SiC

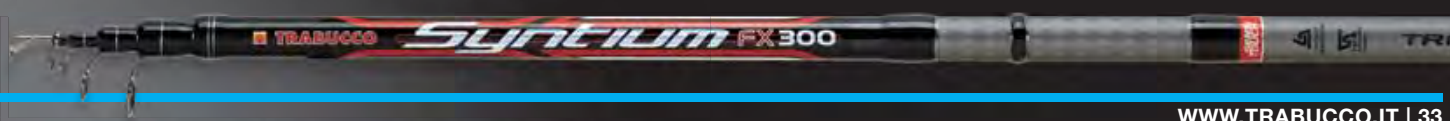



# CANNE TELEMATCH

Most probably, the telematch rod is the emblem of versatility in the Italian fishing scenery, and that's why it has deserved a pretty good reputation in most European countries as well. Beyond the obvious waggler fishing, it can solve thousands of problems both in fresh and saltwater fishing. It can catch lake Trout as well as river Trout with lead sinker and earthworms. It can cast floating bombardas for surface fishing at sea

side, but it's also powerful enough to serve paste bait to Grass Carp and drive them to the landing net. We have seen it light drifting from the boat for Mackerel, and even used as heavy feeder for Barb, as the tubular top is equally at home in fast running rivers. Strong and powerful rods to bear everything, including the injuries coming from the newcomer's rough hands!



## VANADIA XT-MATCH

Among the vast population of telematch lovers, many are those who prefer the carbon handle instead of traditional cork one. That's why Trabucco also offers rods like Vanadia XT, which show an impressive Super Slim butt considering the tremendous power it can deliver. The concept seems to push these rods into Bolognese fashion, but once in your hands, it's clear that the slightly upper reel seat is there to help you push as much as you like. In line with such need, the body of these rods is engineered to be heavily loaded, thus boost heavy wagglers to the horizon. The job is done by CX-1 Micro Pitch carbon, whose structure is so tight that the blank's answer is strong and neat, without oscillations. The blank is further powered and protected by a cross winding carbon yarn, which is purposely missing on top section to generate a perfect action curve. A great feeling comes from Sensi Touch finish of

**CW** CROSS WINDING

**SENSI TOUCH**

**SS** SUPER SLIM BLANK

**CX-1** CARBON MICRO-PITCH

handle area, proving the Trabucco's attention to details. Guides are short leg HD model, able to quickly disperse heat caused by the endless line flow, an essential part of waggler fishing.



Blanks made from Micro Pitch Carbon CX-1 (Super Slim).



Medium leg HD guides (quick heat dissipation).

Code	Length	C. Length	Weight	Sections	C.W.	Guides
150-34-450	4.50	130	202	7	10-60	SiC
150-34-455	4.50	130	208	7	20-80	SiC





## ATTRACTIVE T-MATCH ALLROUND

The T-MATCH ATTRACTIVE ALLROUND is produced in three 4.50 meters models to meet the widest range of power and casting requirements. They don't fear any comparison in terms of toughness and are suitable for challenging fishing styles, when it often comes to lift the fish instead of using the landing net. The blanks, made of super high modulus CX-1 carbon are further enhanced with carbon filaments over the whole length but the tip. High quality components: SiC guides, shock absorber reel seat and non slip rubber painted handle.

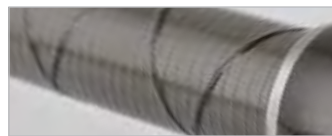

Carbon yarn reinforcement wrapping.

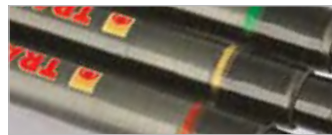

Colour coded wrappings to identify actions.



Medium leg SiC guides.



Shock absorber reel seat and non slip rubber painted handle.

Code	Length	C. Length	Weight	Sections	Action	C.W.	Guides
150-30-100	4.50	130	195	7	MH	10-30	SiC
150-30-200	4.50	130	202	7	H	20-50	SiC
150-30-300	4.50	130	210	7	HH	30-80	SiC



## TITAN TELEMATCH

In a segment often dominated by boring design, with rods often looking all similar, only Trabucco's know-how could have changed things and stand up above the rest. Now his R&D team does it with new Titan, the most sensitive telematch rods around. Everybody knows that the rod's power comes from the body, while casting accuracy and hook setting are provided by top and second section, specially when top tip is remarkably fine, as on Titan Telematch. When the rod is employed on lake trout fishing or with bombarda at seaside, this is even more evident, because fish's bite is made evident by the rod's tip. Then, control and sensitivity become vital ingredients of success, so an important role is played by the wonderful Sensi Touch reel seat, which fits into the user's hand like a tailor made glove. Both thumb and fore finger get into direct contact with rod's blank, sending to brain an intense feeling of superior efficiency and perception.

Code	Length	C. Length	Weight	Sections	C.W.	Guides
150-32-420	4.20	129	275	7	30	SiC
150-32-450	4.50	131	280	8	50	SiC



## SELEKTOR T-MATCH

We received many requests for a tough and reliable value for money telescopic match rod. We then created the Selektor T-Match series, a full range of rods having several length and casting weights suitable for many situations. The blank is made of Super High Modulus Radial Carbon, hardened and strengthened by the special Cross Winding technology, consisting in a double carbon ribbon crisscrossed along the whole length of each section. The rod is very fast during casting and able to strike rapidly. These

rods are not expensive but they are equipped with very good components, such as SiC guides, natural cork handle with EVA inserts and ergonomic reel seat.



Code	Length	C. Length	Weight	Sections	C.W.	Guides
151-92-420	4.20	129	315	4	10-30	SiC
151-92-425	4.20	129	330	4	20-60	SiC
151-92-450	4.50	137	360	4	10-30	SiC
151-92-455	4.50	137	380	4	20-60	SiC



## ORBITRON NRG MATCH



Blank made of SHMR carbon further reinforced with the use of Cross Winder technology that uses a winding of carbon wire distributed throughout the whole length of the rod. This is a so versatile rod, with excellent technical features exploited by those who likes match fishing for trout in the lake, fishing from the rocks on the sea and even by those who fish from the boat. The series consists of three actions distributed in two lengths 4.20m and 4.00m. Rods equipped with S-SiC guides, shock absorber reel seat and non slip paint on butt section.



Code	Length	C. Length	Weight	Sections	C.W.	Guides
151-87-405	4.00	129	268	5	8-25	S-SiC
151-87-420	4.20	133	320	5	10-30	S-SiC
151-87-425	4.20	133	330	5	20-50	S-SiC



## NEW REVENTON VX TELEMATCH

Wherever you need a powerful rod, not only to cast wagglers of considerable size, but also to stop the run of an important fish, the Reventon VX provides his muscles made from High Resistance carbon and its medium leg SiC guides, fixed by excellent wrappings. In your hands, a solid screw reel seat made by graphite and steel, nestled in a natural cork handle, the most comfortable material during hot weather as well as in the coldest winter. On the lake or in the sea, its reliability will let you focus on the action, without risk of technical problems or structural failure.

Code	Length	C. Length	Weight	Sections	C.W.	Guides
151-95-360	3.60	112	240	5	10-50	S-SiC
151-95-390	3.90	125	260	5	10-50	S-SiC
151-95-420	4.20	125	330	5	10-50	S-SiC
151-95-450	4.50	125	350	6	10-50	S-SiC



## SYNTIUM TELEMATCH

**CW CROSS WINDING** S.H.M.R. CARBON

Cast, cast and still cast. This is the test that has undergone this product at the design stage. The purpose of this rod was long casting and consequently the design efforts were focused in that direction. We have used SHMR Carbon with a special reinforcement named W-Power. This allow a newbie too to cast a waggler as far as 90 meters!



These rods are so powerful and resistant you can even lift big fishes with no problem when fishing in salt water, from rocks or piers. The range covers

all the different actions and enables fishing with many different weights and size of waggler floats. Before buying an match rod of any competing brand, ask your dealer to let you try one of our rods of the same price range. At that point you will have no more doubts.

Code	Length	C. Length	Weight	Sections	C.W.	Guides
151-89-400	4.00	116	247	4	40	SiC
151-89-405	4.00	116	262	4	60	SiC
151-89-420	4.20	116	315	5	80	SiC



## NEW ERION XT MATCH

**CROSSED REINFORCED** high precision control

With their progressive action, which adapts the blank's response to the pull of the fish, these great rods are appreciated in many fishing circumstances. The catches of small-medium sized fish, such as Bream and Carassios or Garfish and Saddle Bream, the fish retrieve takes place smoothly. When, however, on the other side of the line there is a four-wheel drive demon, it's the body of the rod which makes them feel that there is no escape, thanks to its carbon blank and its crossed reinforced joints. The elegance of the cork grip, with EVA functional inserts, reminds us that fishing is a pleasure, while the SiC guides allow the use of braided lines.

Code	Length	C. Length	Weight	Sections	C.W.	Guides
151-96-400	4.00	124	270	5	10-80	S-SiC
151-96-420	4.20	128	320	6	10-80	S-SiC



## NEW REVENTON ALLROUND SLIM

Although fishing is going through an era of great specialization, with tackle more and more designed to face a single fishing technique, there is still a strong demand about allround rods, to be kept in the car's booth just in case. Compact closed length, reliability and good casting power are the basic requirements, which we have all fitted into the new Reventon Allround. The relatively slim blank, made from High Resistance carbon, the comfortable and easily washable EVA grip plus the SiC guides make these great rods quite nice and durable, as well as suitable to fish with float, with bombardas, bottom leads and floating feeder, as well as hunting predators with livebait.

Code	Length	C. Length	Weight	Sections	C.W.	Guides
151-97-100	3.30	98	290	6	10-30	S-SiC
151-97-200	3.30	98	310	6	20-60	S-SiC
151-97-300	3.30	98	330	6	40-80	S-SiC
151-97-400	3.60	98	330	6	20-60	S-SiC
151-97-500	3.60	98	350	6	40-80	S-SiC



# CANNE MATCH

When an Italian Company sells match rods to the UK Market, it means that these rods have been designed really well: this is the result obtained by Trabucco. Our UK consultants provided all the essential elements to create a product that respects tradition and technique, then the team of Italian champions have managed to combine these features with all the needs for fishing in continental waters, and finally gave Trabucco the latest manufacturing technologies on the market. Finally the results is an unrivaled range of match rods able to provide highly specialized and appropriate rods. Does not exist a company with such a vast range of match rods.

## **NEW** ENERGHIA 2K MATCH EXTREME



Developed to face the extreme fishing conditions of certain lakes and the widest canals, this special series impresses already at the first contact for her extraordinary body's stiffness. The first meter above the handle is able to absorb a huge power, returning it with an amazing projection of large wagglers. Such a lot of power is not only necessary to send on the opposite bank the 30 and 35 grams wagglers, but also to beat the force of the wind, very frequent in those environments. The blank is structured in High Modulus Radial Carbon for an outstanding responsiveness, and is accompanied by the fantastic Fuji Match Alconite. Unparalleled handle made from cork of the highest quality, with the IPS Fuji reel seat to provide a firm and easy grip.

Code	Length	C. Length	Weight	Sections	C.W.	Guides
153-22-450	4.50	155	210	3	10-35	Fuji A
153-22-480	4.80	165	240	3	10-35	Fuji A

## ENERGHIA 2K MATCH POWER



The 2K Match Power complete the wide Energhia range, without any presumptions, the most beautiful and famous match rod series in the world. The blank, made from High Modulus Radial Carbon, can develop the power to shoot 30 grams wagglers up to 100 meters away. In this model we have applied the latest technology, research and design available. Superb components and finishes: Fuji guides, Fuji reel seat and AAA cork handle. This rod is dedicated to all those who want to complete their series of Energhia match rods.

Code	Length	C. Length	Weight	Sections	C.W.	Guides
153-21-450	4.50	155	200	3	10-30	Fuji A



Match rods are intended to withstand heavy stress, especially while casting, when the weight of the waggler along with the opposing force of the wind can generate an explosive mix. For this reason the Energhia Match joints are made and refined under computer's assistance: only with extreme precision it's possible to perfectly match male and female parts, obtaining full cooperation between them and, consequently, a very high strength.





# ENERGHIA 2K

## ENERGHIA 2K MATCH PLUS



We do believe to have built the best match rod in the world: no gimmicks and no compromises. And we also decided to ignore the price! Yes, it costs but it is worth every single cent you spend for it! Countless testing hours, the best materials on the market, the best technology, all of this is included in the two models. For sure it is not a rod for everybody, unexperienced anglers won't get even the 50% of these rods potential. But serious and experienced anglers will have in their hands rods able to cast very very far and very accurately. Super slim High Modulus Radial Carbon blanks, light as a feather, equipped with genuine Fuji guides and reel seat, AAA cork handles. The most impressive qualities are the incredible tip action and a progressive blank that no other brand can match. If you try them you will fall in love. We give you our word!

Code	Length	C. Length	Weight	Sections	C.W.	Guides
153-18-450	4.50	155	200	3	8-25	Fuji A
153-18-480	4.80	165	225	3	10-30	Fuji A

## ENERGHIA 2K MATCH



The 2K Plus serie was missing of a 4,20 meters model and so we decided to build it. The blank has been built in Super High Modulus Radial Carbon and equipped with genuine Fuji Alconite guides and cork with EVA inserts handle. When you start using this rod with a 10-15 grams waggler you can really understand the essential quality of this project. Even if it is the shorter of the 2K Plus, it can cast as far as the others and with the very same accuracy. And when fighting the fish this rod is even more amusing. If you want to push your limit, take this rod and you will discover a new world in match fishing.

Code	Length	C. Length	Weight	Sections	C.W.	Guides
153-18-420	4.20	144	155	3	5-20	Fuji A



Due to the continuous flow of the line, in the cast but also in the retrieve, on match rods the guide's quality is really crucial. If it's natural to pay attention to the inner ring, because it gets in contact with the line, the consideration to the frame is less immediate, even though it's equally as important. Its rigidity must be high in order to avoid oscillations which would damage the line. In this sense, the Fuji Alconite Match guides offer an absolute safety.





## **NEW** SYGNUM XS PRO WAGGLER



Within the renewed Sygnum range, this series has a special role, thanks to its dual identity. Favors and funs lovers of the most traditional English action, known as Waggler in the UK, with a gentle curve which safely controls the most important fish even with light lines. Tackles the relatively short fishing distances with the ability to fully absorb the strike's efforts, which otherwise would dangerously overload the hooklink. The CX-1 Micro Pitch carbon blank makes it belong to elite class match rods, because in action it develops an unexpected reactivity, higher than imagined at the time of purchase. The rings are reliable, with the SiC ring and a rigid frame; the handle comes from an ultra-classic design, with natural cork artfully shaped and reinforced by an hybrid zone at the lower end.

Code	Length	C. Length	Weight	Sections	C.W.	Guides
157-71-420	4.20	145	190	3	8-25	SiC
157-71-450	4.50	155	210	3	8-25	SiC

## **NEW** SYGNUM XS PRO ENERGY



Powerful, precise, lightweight, it's the Sygnum which has the widest application field, ranging from the canal to the lake, up to the slow running river to be tackled with a sliding waggler. The two sizes are designed to offer different levers, depending on the fishing conditions, always with optimum handling. The progressive action allows to cast fairly heavy wagglers and fight with authority any fish of a certain size: in front of a mixed chances, with possible bonuses, these are the right rods. Only the guide on the butt section is a double leg model; all the others are single leg for lightness reasons but also to let the rod develop its nice action. The handle is made from natural cork, while the fore grip is soft EVA.

Code	Length	C. Length	Weight	Sections	C.W.	Guides
157-72-420	4.20	145	200	3	10-30	SiC
157-72-450	4.50	155	220	3	10-30	SiC

### FEATURES:

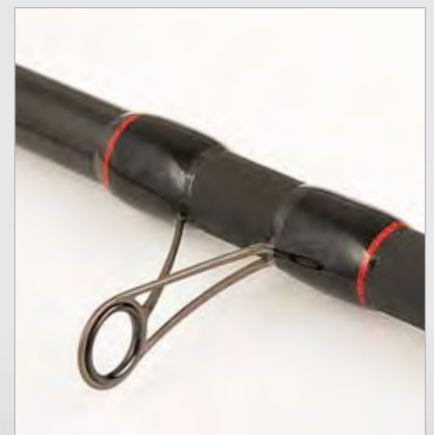
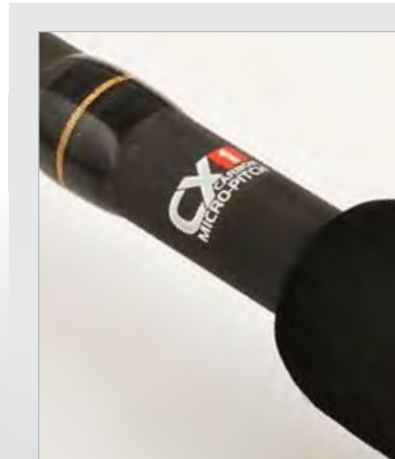



## NEW SYGNUM XS PRO DISTANCE



His vocation is all in the name: distance. In the wider canals it means casting to the opposite bank consistently and accurately; a joke, for a CX1 Micro Pitch carbon blank, which responds like a guitar string, even when it is loaded by a 35 grams super waggler. The top section is anything but rigid, while offering the curve that is now essential for the successful landing of large Bream, even when the hook is relatively small enough and fine. One size only, fifteen feet, the right compromise between power and handling, because the execution speed of the cast is a vital prerequisite to achieve certain distances. SiC rings have programmed diameters for the use of shock leader, with single leg frame. Great grip comfort, with the classic cork and screw reel seat.

Code	Length	C. Length	Weight	Sections	C.W.	Guides
157-73-450	4.50	155	230	3	15-40	SiC

## SYGNUM XS PROLITE

Prestige rods series with slim diameters and lightweight blanks, made using the Carbon Nano Technology. This model has a progressive action and is able to cast a wide range of weights at long distances. Well suited for fishing with thin monofilament even if bigger diameters are well supported. Fitted with new T-Sic Ultra-Light guides and a new concept reel seat and cork handle.

Code	Length	C. Length	Weight	Sections	C.W.	Guides
157-69-420	4.20	145	172	3	5-20	SiC
157-69-450	4.50	155	195	3	5-20	SiC





# SYGNUM MRX-V



## NEW SELEKTOR XS ACTIVE MATCH



For its technical specification and brilliant fishing performance, this series can shock you when you are aware of its affordable price! Nothing new for the Trabucco brand, but the world is full of match rods that are sitting at much higher cost levels, without offering the same degree of performance.

Two medium heavy action rods, differing in length at 4,20 and 4,50 meters, plus a third one that is destined to hard work, to cast wagglers belonging to the range of 10 to 30 grams. Classically dressed under Selektor standard, with handle in natural cork combined with EVA in areas subject to more wear and integrated reel seat, with no excess shape. SiC single leg guides.

Code	Length	C. Length	Weight	Sections	C.W.	Guides
157-76-420	4.20	145	215	3	MH (8-25)	SiC
157-76-450	4.50	155	250	3	MH (8-25)	SiC
157-76-455	4.50	155	260	3	H (10-30)	SiC



# SYGNUM MRX-V



The new SYGNUM MRX-V is a really complete series of rods designed to cover all the demands of modern fishing methods. From small lakes to river fishing for chub, barbel and bream or in commercial fisheries that require long distance casting with heavy wagglers. We used Super High Modulus Carbon perfectly to get the necessary stiffness for long and precise casting and the essential flexibility for catching big fish with low diameter lines and light tackle. Manufactured with the very highest quality materials and finishing such as the high grade cork handle, genuine Fuji reel seat and S-Sic guides.

Code	Length	C. Length	Weight	Sections	C.W.	Guides
151-19-390	3.90	136	198	3	3-15	SiC
151-19-391	3.90	136	203	3	5-20	SiC
151-19-392	3.90	136	206	3	8-25	SiC
151-19-421	4.20	145	218	3	8-25	SiC



# SYGNUM XT



## SYGNUM XT WAGGLER

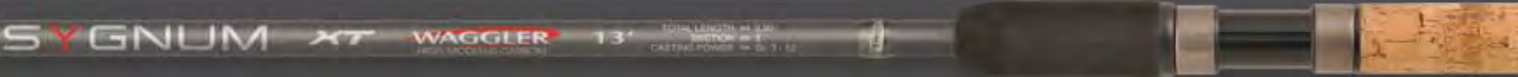

Designed for waggler fishing and available in 13' length this rod is constructed with the new SUN SCREEN FINISH and uses Super High Modulus Carbon with High Resistance Carbon reinforcement in the stress points to increase overall reliability. Equipped with long leg SiC Light Frame guides, ergonomic reel seat mounted on natural cork and high density EVA handle. Perfect action - progressive and very powerful. Extremely manageable and light, ideal for up to 12 g wagglers and for either low diameter line or heavier duty line for a large fish.

Code	Length	C. Length	Weight	Sections	C.W.	Guides
151-22-390	3.90	138	148	3	3-12	SiC

## SYGNUM XT POWER

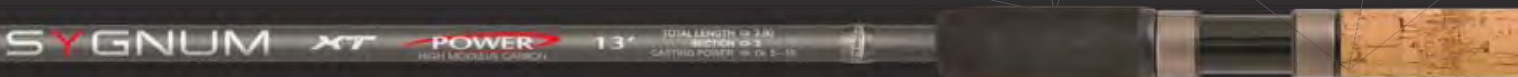

This 13' Sygnum XTPower Waggler is assembled with SiC Light Frame guides, ergonomic reel seat mounted on natural cork and high density EVA handle. It features a progressive action for long, precise casting with medium-heavy weight. It is the perfect rod for carp and bream over medium to long distances. Its slim diameter blank increases the lightness and manageability of the product without compromising reliability. High quality finishing and components.

Code	Length	C. Length	Weight	Sections	C.W.	Guides
151-23-390	3.90	138	145	3	5-15	SiC

## SYGNUM XT POWER PLUS



A step up from the Power version the Power Plus Waggler rod comes in 13' and 14' lengths. Assembled with SiC Light Frame guides, ergonomic reel seat mounted on natural cork and high density EVA handle. Progressive action for long, precision casting with medium-heavy weight up to 20 gr. Designed for speed fishing, that is when there is a great quantity of fish and you need a very good casting accuracy and a good power to reel in preys very fast. The action is also good to face bigger fish.

Code	Length	C. Length	Weight	Sections	C.W.	Guides
151-24-390	3.90	135	174	3	5-20	SiC



## ERION XT MATCH PRO



Made from super high modulus Durawall carbon and fitted with Sic. The blank is slender, while the action is progressive, providing long cast performance and being always ready to fight the fish. These rods are equipped with ergonomic reel seat and cork with EVA inserts butt section. Two actions designed for easy fishing for fish carp, bream and crucian carp.

Code	Length	C. Length	Weight	Sections	C.W.	Guides
151-56-420	4.20	145	248	3	5-20	SiC
151-56-450	4.50	155	259	3	8-25	SiC

## ERION XT CARP PRO



Match fishing rods built with great accuracy, created for fishing big fish also at long distance. The reliability of the blank has been obtained by using super high modulus carbon Durawall, which is not only super strong but it is also remarkably light weight and sensitive. EVA and cork handle is particularly comfortable. Equipped with SiC guides for better heat dissipation.

Code	Length	C. Length	Weight	Sections	C.W.	Guides
151-47-390	3.90	137	204	3	8-25	SiC
151-47-420	4.20	145	232	3	8-25	SiC

## NEW ERION XT SPECIALIST



The specialist category is made by anglers who concentrate their fishing time and efforts to a single fish species with great determination, chasing their personal best record. Carp, Tench, Barbel are leading the list of dreams, which come true through reliable, manageable, powerful and light rods like these Erion XT. Built from High Resistance carbon to fully bend without damage, they have a short closed length and a corrosion free Sea Guide guides configuration. The grip is made of natural cork, with hybrid inserts for superior durability and strong screw reel seat in graphite and steel. Erion logo hot printed on the butt is a touch of classic elegance.

Code	Length	C. Length	Weight	Sections	C.W.	Guides
151-48-360	3.60	127	240	3	10-45	Sea Guide SiC
151-48-390	3.90	137	270	3	10-45	Sea Guide SiC



## PRECISION XT MATCH PLUS S.H.M.R. CARBON

Series of two powerful rods made of Super High Resistance Carbon. The rods are very well finished, using ergonomic reel seats, ultra light S-SiC guides and natural cork with EVA inserts handles. The action is powerful but can be easily calibrated, being effective even when using light rigs. The casting power is very good (30g for 4.20m model), and very good is the sensitivity as well. We designed a peculiar very thin tip section and a conical blank to get the sensitivity we needed. It is an easy to use match rod suitable for fishing at medium and long distance targeting breme, carp and crucian.

Code	Length	C. Length	Weight	Sections	C.W.	Guides
152-30-390	3.90	137	186	3	8-25	S-SiC
152-30-420	4.20	145	220	3	8-25	S-SiC
152-30-450	4.50	155	249	3	10-30	S-SiC



## PRECISION XT MATCH CARP S.H.M.R. CARBON

This is a really powerful but funny series. The blank has been designed using a conical shaped design, getting a tip-progressive action. If you take these rods in your hands you can clearly understand how handy they are and the power built inside the whole blank, able to calm down the more challenging fish. We suggest you to choose your model upon your casting needs: the longer the cast, the longer the rod. Precision Match Carp are equipped with S-SiC guides and natural cork with EVA inserts handle.

Code	Length	C. Length	Weight	Sections	C.W.	Guides
152-31-360	3.60	126	182	3	5-20	S-SiC
152-31-390	3.90	137	210	3	5-20	S-SiC
152-31-420	4.20	145	235	3	5-20	S-SiC

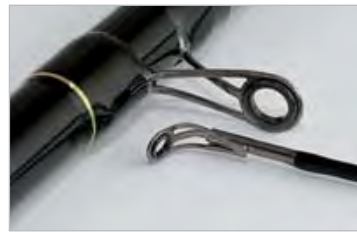

## PRECISION XT ALLROUNDER S.H.M.R. CARBON

These are true allround rods, being able to cast very far and to fight huge fish. Precision Allround and made also for speed fishing, very useful when you need to land your fish in the shorter time possible. Coming back to its casting skills, when we state it is able to cast very far, we really mean very far: as far as over 100 m with 40 or 60 g wagglers (depending on the model you are using). This exceptional results can be obtained only using very good materials such as the Super High Resistance Carbon Durawall, the stronger, tougher, more reliable Carbon on the market, in combination with reinforced joints between sections. The rod uses wider S-SiC guides and a natural cork handle.

Code	Length	C. Length	Weight	Sections	C.W.	Guides
152-32-360	3.60	126	158	3	15-40	S-SiC
152-32-365	3.60	126	163	3	20-60	S-SiC



## SYNTIUM MATCH CARP



These two rods are born for carp fishing. Two different lengths having the same casting power: 5-20 grams. Made using Super High Modulus Durawall Carbon with Crossed Reinforced technology. Equipped with Power Joint system to avoid blocking sections, Super S-Sic Light guides, natural cork and EVA antislip handle and ergonomic reel seat. Recommended for top water carp fishing in commercial fisheries or for long distance fishing in big lakes.

Code	Length	C. Length	Weight	Sections	C.W.	Guides
151-61-330	3.30	116	179	3	5-20	S-SIC
151-61-360	3.60	127	190	3	5-20	S-SIC



## SYNTIUM CARP PLUS



Super powerful rods developed in two sections with two different lengths (3.00 and 3.30). As for the whole series Syntium all the blanks are very thin because they are made in Super High Modulus Durawall Carbon but at the same time very powerful and reactive. Crossed Reinforced and Power joint to avoid blocking sections. Assembled with SIC Light frame guides, natural cork and EVA anti-slip handle. These two pieces rods are very funny and very pleasant to use. Two rods born to catch a lots of fish in a short time!

Code	Length	C. Length	Weight	Sections	C.W.	Guides
151-62-300	3.00	155	163	2	5-20	S-SIC
151-62-330	3.30	168	176	2	5-20	S-SIC



## XPS MATCH SINKING

Japanese production monofilament made especially for waggler or feeder fishing. The main feature of this innovative monofilament is its high specific weight which allows it to sink extremely easily. Special surface treatment ensures high abrasion resistance and total absence of memory, both fundamental for this type of fishing where the line is subject to great stress.



Find out more on page 207

## XD MATCH FLOATS SERIES

The Trabucco XD match floats, where XD stand for perfection and are individually hand made with maniacal accuracy. They equipped with a carbon tube to increase stability and sensitivity, having a lower diameter if compared to a traditional peacock quill. They are the ideal choice for long distance fishing in canals and lakes for difficult fishes like crucian and breme. The HD floats are sol with two interchangeable tips of different diameter.



Find out more on page 270

# CANNE FEEDER

Despite his knowledge has spread all over Europe for more than forty years, the feeder fishing technique continues to evolve as a few others, not only for the continuous creation of new feeder models, but also for the expansion of its application horizons. Today, fishing in the commercial lakes takes an important share of the specific scenario, even if the

more exciting segment is match fishing, finally alive and well regarded also in Italy. The use of braided lines grows without pause, making soft action rods more and more in demand. All these requirements find a proper answer by Trabucco brand, whose research and development team continues to succeed in creating nice rods at all quality levels.



## NEW ULTIMATE STILLWATER FEEDER

Light, very light and balanced despite the absolute structural reliability, born from an ambitious project that takes into account not only the primary need to catch fish, but also the feelings of the user. Thus a fantastic handle has been designed, with the flat area that improves casting and fighting control, and a rubber painted reel seat, finely decorated by a woven carbon segment, embedded in the short EVA fore grip. If the handle hits the senses, actions are appreciated for their delicacy in the light stillwater fishing, especially for bream, but also for the ability to neutralize the four-wheel drive of any bonus fish. Sea Guides with SiC ring are a guarantee in the management of braided lines and ensure long life of use.

Code	Length	C. Length	Sections	Action	C.W.	Guides
150-92-300	3.00 / 10'	155	2+4	M	75 g	SiC
150-92-330	3.30 / 11'	170	2+4	M	75 g	SiC
<b>Spare Tips</b>	<b>1S</b>	<b>2S</b>	<b>3S</b>	<b>4S</b>		
	150-91-010	150-91-020	150-91-030	150-91-040		

\* Ultimate Stillwater Feeder 300 e 330 Tips Array: Action 1s, 2s, 3s and 4s.

Code	Length	C. Length	Sections	Action	C.W.	Guides
150-92-360	3.60 / 12'	127	3+4	MP	90 g	SiC
150-92-390	3.90 / 13'	136	3+4	MP	90 g	SiC
<b>Spare Tips</b>	<b>1UL</b>	<b>1</b>	<b>2</b>	<b>3</b>	<b>4</b>	
	150-91-100	150-91-110	150-91-120	150-91-130	150-91-140	

\* Ultimate Stillwater Feeder 360 e 390 Tips Array: Action 1UL, 1, 2 and 3.

The spare tips for Ultimate Stillwater feeder are also available separately.



Supplied with four interchangeable carbon quiver tips: actions 1UL, 1, 2 and 3 for three section rods; actions 1S, 2S, 3S and 4S for two sections rods.



# ULTIMATE



## NEW ULTIMATE MASTER FEEDER

Within the Ultimate range, these are the intermediate rods, structured to cast the feeder to good distance, thanks to the responsiveness of CX-1 Micro Pitch carbon. Ideal for the stillwater match fishing to Bream and Carassius with Method or Rocket Cage feeders, they are equally at home in the river fishing with Blockends. The Ultimate natural cork handle, flattened in the middle for optimal adherence to the user's forearm, is a real wonder of taste and functionality. SiC rings are super reliable, as they are signed by Sea Guide. The four quiver tips supplied with the rod, all made from carbon, enable to cover all options, allowing you to positively tackle, in case of need, also a short line fishing range.

Code	Length	C. Length	Sections	Action	C.W.	Guides
150-93-360	3.60 / 12'	127	3+4	MP	90 g	SiC
150-93-390	3.90 / 13'	136	3+4	XP	110 g	SiC
150-93-420	4.20 / 14'	147	3+4	XP	110 g	SiC

\* Ultimate Master Feeder Tips Array: Action 1, 2,3 and 4

The spare tips for Ultimate Master and Ultimate Distance feeder are also available separately.



## NEW ULTIMATE DISTANCE FEEDER

The setting of the handle, with the reel seat relatively high and the conical butt grip, says everything about the vocation of these wonderful tools: casting, first of all, because when fish feed at the horizon you must get there, absolutely. But it's not sure that so far the fish are large and easy, so the supply of four interchangeable carbon quiver tips is well founded, as it can easily fix any fishing condition. The rod's lengths are naturally long, from 3.60 to 4.20 meters to provide the obvious lever and to hold the fishing line out of the water when necessary. Great comfort with the reel seat painted in rubber; extreme respect for the line with the Sea Guide SiC rings, whose configuration allows the use of shock leader.

Code	Length	C. Length	Sections	Action	C.W.	Guides
150-94-360	3.60 / 12'	128	3+4	MH	100 g	SiC
150-94-390	3.90 / 13'	135	3+4	H	130 g	SiC
150-94-420	4.20 / 14'	147	3+4	H	130 g	SiC

Spare Tips	1UL	1	2	3	4
	150-91-100	150-91-110	150-91-120	150-91-130	150-91-140

\* Ultimate Master Feeder Tips Array: Action 1, 2,3 and 4







*A so complete, performing and well finished series of rods that will deeply impress all the anglers that will test them.*

## SYGNUM MRX-V FEEDER



Series of top quality and high value feeder rods. suitable for the European market. All these rods offer unbelievable quality and are made of High Modulus Carbon and finished with heavy duty SiC guides and genuine Fuji reel seat. Well balanced and lightweighted these rods still have enough power reserve to fight bigger fish. Sygnum Mrx-V comes with 3 carbon quiver tips. suitable for both light feeder fishing and heavier feeders. good for commercial fisheries.



Comes with tips:  
 Quiver 11M 3/4. 1. 1 1/2 Oz  
 Feeder 12M 3/4. 1. 1 1/2 Oz  
 Feeder 13MP 2.3.4 Oz



These rods are equipped with braid resistant SiC guides.



Sections identified by screen printings.



Integrated reel seat and natural cork handle.

Code	Model	Length	C. Length	Sections	Action	C.W.	Guides
151-16-330	Quiver	3.30 / 11'	115	3+3	M	75	SiC
151-16-360	Feeder	3.60 / 12'	125	3+3	M	75	SiC
151-16-390	Feeder	3.90 / 13'	135	3+3	MP	125	SiC

\*Spare tip set available separately code 151-16-330/360/390-R01

# SYGNUM



## SYGNUM XPS COMPETITION



Feeder fishing is booming all over Europe as well as in Italy, and anglers grow both in number and skills. Consequently, also the demand is changing, with rods getting more and more specialized to handle a certain type of feeder, to face a definite sort of water or even to expressly suit a particular match venue. This is possible at Trabucco team, because the technicians can easily transfer their individual experiences into performing rods as soon as they feel it's time to create a new one. Top of the range Sygnum now

expands with two special XPS Competition models featuring an impressive compromise between casting power and blank's lightness. A 12' with 90 grams casting weight and a 13' able to handle 125 g heavy feeder, both supplied with 4 quiver tips to allow accurate sensitivity according to conditions, because even the beefiest set-up can sometimes require a fine sensitivity. The wonderful SiC guides can handle braided lines without fear, while the classic cork handle with reliable screw reel seat offers plenty of control.

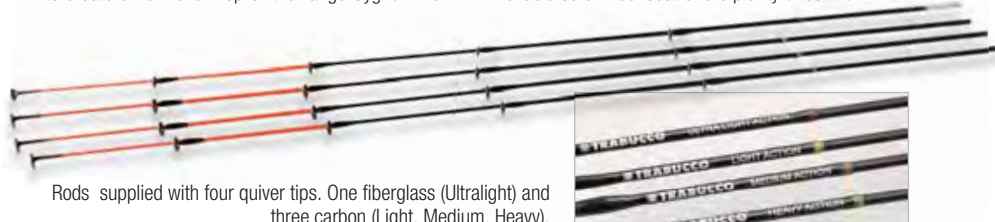

Rods supplied with four quiver tips. One fiberglass (Ultralight) and three carbon (Light, Medium, Heavy).



Double leg MN SiC guides (single leg on top section).



Spiral wrapping on joints. Screw reel seat made from steel and rubber. Cork handle with EVA fore grip and hybrid cork butt cap.

Code	Length	C. Length	Sections	Action	C.W.	Guides
151-02-360	3.60 / 12'	125	3+4	MP	90	SiC
151-02-390	3.90 / 13'	134	3+4	MP	125	SiC

\*Spare tip set available separately code 151-02-360-R01

## SYGNUM XPS FEEDER



These excellent feeder rods really stand up from the crowd due to their incredible strength and power, perfectly distributed all over the blank. It is hard to give you a suggestion about where to use them, cause they can match so many situations: you can fish big breme in canal, powerful barb in the river

and huge carp in the lake. Sygnum XPS Power Feeder comes with 3 solid carbon tips, sensitive and powerful. These rods are equipped with braid resistant SiC guides, integrated reel seat and natural cork handle.

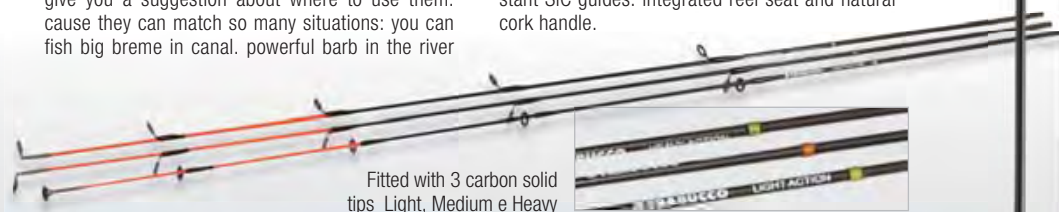

Fitted with 3 carbon solid tips Light, Medium e Heavy

Code	Length	C. Length	Sections	Action	C.W.	Guides
151-11-390	3.90 / 13'	137	3+3	XP	150	SiC
151-11-420	4.20 / 14'	146	3+3	XP	150	SiC

\*Spare tip set available separately code 151-11-390-R01





## SYGNUM TXL SUPREME FEEDER



Among competition rods, the feeder ones are those who must face the toughest life, because they must bear tremendous loads while casting and strong pulls while fighting big fish such as carp, barbel and even catfish. All of us like those exciting catches, but also like light and slim rods, apparently not compatible with those fast running beasts. But it's Trabucco know-how and technology which comes into play to let both worlds live together. Advanced CX-1 Micro Pitch carbon provides lightness and sharpness, while a carbon yarn braiding protects the blank from risky deformations and odd shocks. Such cooperation is so effective that pushes blank's responsiveness beyond any limit: when it's time to put our bait out there to reach those shy fish, it's just a matter of loading the blank and look at the feeder flight. Magi!

Code	Length	C. Length	Sections	Action	C.W.	Guides
150-90-360	3.60 / 12'	125	3+4	M	75	SiC
150-90-365	3.60 / 12'	125	3+4	MH	90	SiC
150-90-390	3.90 / 13'	134	3+4	MH	90	SiC

\*Spare tip set available separately code 150-90-360-R01



Natural cork handle with EVA handle grip. Screw reel seat made from steel and rubber. Blanks reinforced by carbon braiding.

## SYGNUM TXL ADVANCED RIVER



Feeder fishing in big rivers always require longer rods, to take away your line from water pressure as much as possible. In this way you avoid also the line dragging too much and avoid the risk of friction against the rough bottom. We designed these rods specifically for big rivers and decide to go for 3.90, 4.20 and 4.50m length. Each rods is equipped with 3 tips (light, me-

dium and heavy action), each of them very well calibrated for casting heavy feeders. The whole blank has been made of the brand new Cx-1 Micro Pitch Carbon, reinforced in every joint for added reliability. The rod is finished with ergonomic EVA handle and braided friendly SiC guides, double leg guides for second and third section, single leg for tips and first section.

Code	Length	C. Length	Sections	Action	C.W.	Guides
151-13-390	3.90 / 13'	134	3+3	H	160	SiC
151-13-420	4.20 / 14'	146	3+3	H	160	SiC
151-13-450	4.50 / 15'	156	3+3	H	160	SiC

\*Spare tip set available separately code 151-13-390-R01

### FEATURES:

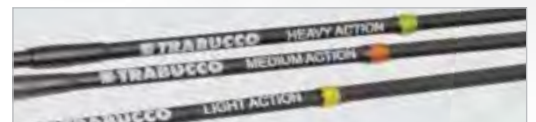

Each rod is supplied with three tips, ideal to handle heavy feeders.

## SYGNUM TXL LONG DISTANCE



These are light weight, well balance and super casting rods. We designed these rods for fishing huge barb in big rivers, using feeders up to 100g. Of course they can be used in canals and lakes whenever you need to cast a method or an open

end feeder at very long range. The super slim blank is made of CX-1 Micro Pitch Carbon, super light and high performance. The equipment includes braided friendly SiC guides double legs. The three tips have single legs guides.

Code	Length	C. Length	Sections	Action	C.W.	Guides
151-14-390	3.90 / 13'	134	3+4	H	130	SiC
151-14-420	4.20 / 14'	146	3+4	H	130	SiC

\*Spare tip set available separately code 151-14-390-R01



Now the TXL Long Distance is supplied with a fourth, ultralight tip with right action for bream long range fishing with braided lines.



Spiral thread wrapping destined to reinforce joints and act as grip for rod's dismantling.





SIC guides enable to use Sygnum TXL rods with braided lines.



Rods equipped with 4 quiver tips: one fiberglass Light action and three carbon quiver, Medium, Medium-Heavy, Heavy.

## LANCER CX QUICK RELEASE

4500 / 5500



The spool can be quickly released by pushing the button on top of drag knob.



**NEW**

Each spool features two round line clips.



Find out more on page 159

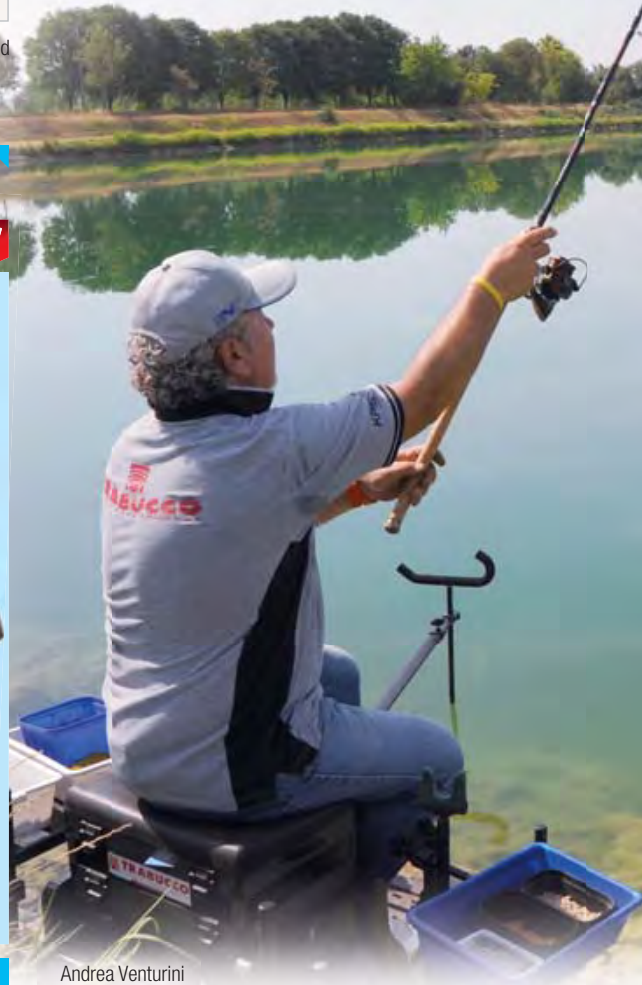

Andrea Venturini



# SELEKTOR



Raffaele Mapelli

**NEW** SELEKTOR  
XS STILL WATER



A real feather in your hands, this fantastic hyper-parabolic designed to face fine stillwater fishing, able to handle thin hooklengths and bring the fight to a positive end by gently driving the fish to the landing net. When fishing at short distance, the Selektor XS Stillwater is almost indispensable, because it shows an amazing ability to absorb the impact of the strike and the first, powerful run of hooked fish. In essence, an ultramodern tool which Trabucco brand enthusiasts waited and welcome with high interest. The CX1 carbon structure consists of two or three sections, depending on the model; the handle is made from natural cork with two EVA grips. Three interchangeable quiver tips, all made from carbon.

Code	Length	C. Length	Sections	Action	C.W.	Guides
152-58-300	3.00 / 10'	155	2+3	ML	50 g	SiC
152-58-330	3.30 / 11'	117	3+3	ML	50 g	SiC
152-58-360	3.60 / 12'	128	3+3	ML	50 g	SiC

Spare Tips	Light	Medium Light	Medium
	152-58-300-R01A	152-58-300-R01B	152-58-300-R01C

SELEKTOR  
XS MASTER FEEDER



This new series has been developed to give a professional answer to demanding match anglers, who mostly fish for bream. As known, the species has a delicate mouth, which require soft action rods to avoid those hook pulls which can scare the shoal and cause dangerous highs and lows in catching rate. The cooperation from rod's blank is also important when fishing at range with braided lines, specially in case of bonus fish fight. All these characteristics are easily detected as soon as the rod is in your hands: the high modulus CX1 Micro Pitch carbon - assembled with minimum amount of resin - gives the blank a magic blend of lightness and sharpness, while it bends smoothly if you try to pull the tip. The three quiver tips are made from solid carbon to provide precision and neat hook setting, even if the size is down to 20 or 22. The cork handle is nicely shaped at bottom end to offer grip and control during accurate casts: a typical competition feature which is well appreciated also by pleasure anglers.

Code	Length	C. Length	Sections	Action	C.W.	Guides
152-55-330	3.30 / 11'	118	3+3	M	75	SiC
152-55-360	3.60 / 12'	128	3+3	M	75	SiC
152-55-365	3.60 / 12'	128	3+3	MH	90	SiC

\*Spare tip set available separately code 152-55-330/360/365-R01



# SELEKTOR XS MULTI FEEDER



An interesting solution allows to expand rod length by one foot. just in case you opt for a longer rig. or you must deal with water flow getting progressively faster through the match or during a pleasant fishing session. Just add the 1' extension and the rod will be immediately adapted to changing conditions. allowing to stay in contact with feeding fish. Therefore. two rods performing like four actually open a new world to the careful angler. allowing him to face canals. lakes and rivers with same nonchalance. Apart from this outstanding versatility. the Selektor XS Multi Feeder has brilliant blanks

made from high modulus CX1 carbon. and is supplied with three carbon quiver tips. The natural cork handle offers plenty of control thanks to hybrid butt grip. plus a nice touch of Italian taste with hot printed Selektor logo.



Natural cork handle with hybrid cork butt grip. Screw reel seat made from steel and rubber. Spiral wrapping on joints. Double leg SiC guides.

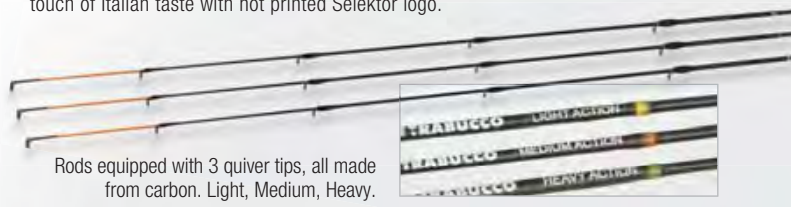

Rods equipped with 3 quiver tips, all made from carbon. Light, Medium, Heavy.

Mini extension (30 cm) to convert the rod into 1 foot longer.



Code	Length	C. Length	Sections	Action	C.W.	Guides
152-57-360	3.30~3.60 (11'/12')	128	3+1+3	M	75	SiC
152-57-390	3.60~3.90 (12'/13')	138	3+1+3	MH	90	SiC

\*Spare tip set available separately code 152-57-360-R01



## NEW SELEKTOR SW ACTIVE FEEDER



Expressly dedicated to sea fishing, where the feeder lives a magical moment thanks to its extraordinary effectiveness, this series of rods offers two combinations of length and power. With the use of CX-1 Micro Pitch carbon and the reinforcement with carbon mesh, the reliability is beyond question, and magically lives together with lightness. The handle is naked, with EVA grip for easy cleaning. Guides are SiC double leg, which become single legs on top area. Three interchangeable carbon tips, Light (yellow), Medium (orange) and heavy (green).

FEATURES:



Each rod is supplied with three interchangeable carbon quiver tips: light, medium and heavy, all with the tip top painted in red, while the colour wrappings on bottom area help to distinguish each one from the others.



Spiral thread wrapping destined to reinforce joints and act as grip for rod's dismantling.

Code	Length	C. Length	Sections	Action	C.W.	Guides
152-59-360	3.60 / 12'	135	3+3	220	MP (100 g)	SiC
152-59-390	3.90 / 13'	146	3+3	240	MP (100 g)	SiC

\*Spare tip set available separately code 152-59-360-R01



## SELEKTOR XS CARP FEEDER

The blank of this series has been designed to redistribute in a progressive way along the whole blank way all the power coming from the run of a big carp. When fighting these powerful fishes it is very important that the rod can absorb the shock with a perfect bend to avoid to break the line or hurt the fish mouth. The best combination is with a medium-heavy feeder for canal and lake fishing. The blank is made of Super

High Modulus Carbon Durawall. Three tips complete the equipment. with three different actions but with the same high visible red colour and wrapping of last guide of different colours for quick identification. SiC guides. ergonomic reels seat and natural cork with EVA inserts handle.



## NEW SELEKTOR XS COMMERCIAL



Designed for commercial fishing, where the Method Feeder is now dominating, these rods develop a balanced compromise between power, sensitivity and sweetness, a feature that reduces the length of the fight if you adopt a steady retrieve, with the fish swimming underwater, never hitting the surface. The progressive parabolic action is ideal for mid range job,

and is capable to protect the hooklink in case of sudden run of the fish. The length of these tools is relatively short, also to adapt to the physical conditions of most lake's pegs, often placed at short intervals. The equal length two section's structure is becoming a classic, because the experts prefer the curve precision than a compact closed length. The three quiver tips supplied with the rod are all made from carbon. The natural cork handle is complemented by the usual hybrid cork butt grip, a Trabucco signature on Selektor class rods.



## NEW PRECISION XT PRO COMMERCIAL

It gets the name directly from the famous English fisheries, known as "commercial" because fishing is subject to a fee, just like in Italy. In those waters there are big carp, but some lakes are even populated by silver fish only: Bream, Roach, Carassius. That's the reason why we have developed a series like Precision XT, which must be able to deal with thousands of situations in the long range fishing, including the fight with a bonus big fish. The configuration with two equal

length sections, with the lightweight guides on the upper part, ensures curve perfection, balance and high resistance. Three interchangeable quiver tips are supplied: two fiberglass (Light, Medium) and one carbon (Heavy). Classic Precision handle, made of natural cork and comfortable EVA grips.

**Power Joint**  **CROSSED REINFORCED**  **CARBON S.H.M. DURAWALL**

Code	Length	C. Length	Sections	Action	C.W.	Guides
152-48-300	3.00 / 10'	155	2+3	M	70 g	SiC
152-48-330	3.30 / 11'	170	2+3	M	70 g	SiC

\*Spare tip set code 152-48-300-R01



Rods equipped with 3 tips  
Light, Medium and Heavy action.



## AIRTEK SPECIALIST

AIRTEK MAGGOT &  
PELLET METHOD FEEDER



LONG DISTANCE FLATBED & MOULD



Find out more on page 321



Code	Length	C. Length	Sections	Action	C.W.	Guides
152-52-360	3.60 / 12'	126	3+3	MH	90	SiC
152-52-390	3.90 / 13'	134	3+3	MH	90	SiC

\*Spare tip set code 152-52-360-R01



Code	Length	C. Length	Sections	Action	C.W.	Guides
156-56-300	3.00 / 10'	154	2+3	M	75 g	SiC
156-56-330	3.30 / 11'	170	2+3	M	75 g	SiC

\*Spare tip set code 152-56-300-R01



Rods equipped with 3 quiver tips, all made from carbon: Light, Medium Light, Heavy.



Marco Busani

### MICRO PELLET FEEDER SET

It is designed to hold micro pellets or groundbaits securely on the cast and with the addition of a matching quick releasing mould with every pack.



## AIRTEK SPECIALIST

### FLATBED METHOD FEEDER & FLEXY MOULD

Available in the Inline or Elasticated version. The Inline is equipped with a swivel for self strike rigging or for sliding rigging, used in combination with a Fast Change Bead. The Elasticated version allows you to use much thinner hook lengths. For both the versions the flat bed grants a strong grip on the bottom, while the peculiar ribbed design keeps the groundbait right in position.

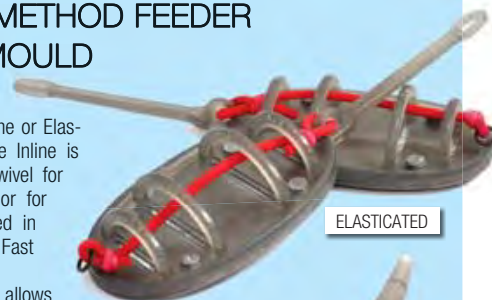

ELASTICATED



INLINE



FLEXY MOULD

This Method feeder is part of a complete program and perform at its best in combinations with the Method Feeder flexy Mould.

1



Put some pre-damped ground bait into the mould and position the hook with the bait in the centre.

2



Fill the mould with the rest of the ground bait, taking care to cover the hook with the bait.

3



Carefully position the Method Feeder in centre of the mould and press firmly.

4



Press the bottom part of the mould to come out the Method feeder with the perfectly shaped ground bait.

5



When the feeder will lay on the bottom the bait will be positioned over the ground bait, that will start its attractive action.

6



When the ground bait will dissolve it will cover the whole feeder, while the bait will be ready to be swallowed by the fish.

Find out more on page 321



# PRECISION

## THE PRECISION PERFORMANCE

We built the Precision series to offer a complete and very differentiated assortment of feeder rods, with performance similar to the top rods on the market, at a very reasonable price. Then we worked hard to design at least one rod for each technique or fishing situation and finally we took care to finish each model with great accuracy, using cork, SiC guides and a special non slip handle.

### PRECISION XT PRO PICKER

A really enjoyable feeder rod that we suggest for short or medium fishing of carp, bream or chub. The light and reliable blank is made of Super High Resistance Carbon. This rod is equipped with SiC guides, so you can use any braided line without any problem, and a comfortable natural cork with EVA inserts handle.

Code	Length	C. Length	Sections	Action	C.W.	Guides
152-40-270	2.70/ 9'	142	2+2	M	35	SiC

\*Spare tip set code 152-40-270-R01

Precision XT Pro Picker are equipped with 2 tips, each of them very well calibrated for casting feeders.



### PRECISION XT PRO BOMB

If you are searching for a reliable and enjoyable rod for fisheries or small and medium ponds, stop here and take advantage of the performance offered by the Precision Pro Bomb. This 3 meters rod will impress you with its incredible ability and elegance to stop the big fish. The blank bends progressively to fatigue the fish little by little but not tiring the angler's arm. The rods displays 3 tips, 2 in fiberglass and one in solid carbon. The whole rod is equipped with braided lines friendly SiC guides and natural cork/EVA handle.

Precision XT Pro are equipped with 3 tips, 2 fiberglass and one solid carbon.

Code	Length	C. Length	Sections	Action	C.W.	Guides
152-40-300	3.00 / 10'	105	3+3	M	70	SiC

\*Spare tip set code 152-40-300-R01

### PRECISION XT PRO QUIVER

We designed this model with a progressive Super High Modulus Radial Carbon and we think it is just perfect for small to medium feeders. It can be used at its best in still water for fishes like chub and roach. It has been equipped with three tips, two in fiberglass and one in solid carbon. It also features integrated reel seat, natural cork with EVA inserts handle and SiC guides.

SiC guides double legs.

Code	Length	C. Length	Sections	Action	C.W.	Guides
152-40-330	3.30/ 11'	105	3+3	M	70	SiC

\*Spare tip set code 152-40-330-R01





Németh Bálasz

## CASTFORCE XT FEEDER

5000 0.300mm/180m 0.350mm/130m 0.400mm/100m

Model specially designed for feeder fishing in rivers and large bodies of water. It is a light weight graphite body reel equipped with a long cast machine cut aluminium spool.

- New design oversized spool
- Line Guard Protector
- Dual Line Clip
- Ergonomic handle with T-Rubber Knob



Find out more on page 172

## PRECISION XT PRO FEEDER



S.H.M.R. CARBON

This series is made of progressive action blanks still having a very good power reserve in the butt section. Very sensitive but powerful and reliable: these three qualities make these rods very good for medium-heavy feeders for fishing in big lakes, rivers, fast flowing canals and even salt water, where they are commonly used in the Mediterranean to fish the distrustful gilt-head bream. Such rods cannot be built if not using the best materials such as the Super High Modulus Radial Carbon. They are equipped with SiC guides and natural cork and EVA handle.

Code	Length	C. Length	Sections	Action	C.W.	Guides
152-40-360	3.60 / 12'	125	3+3	MH	90	SiC
152-40-365	3.60 / 12'	125	3+3	H	110	SiC
152-40-390	3.90 / 13'	137	3+3	MH	90	SiC
152-40-395	3.90 / 13'	137	3+3	H	110	SiC

\*Spare tip set code 152-40-360-R01





## PRECISION XT CARP FEEDER

**Power Joint**  **S.H.M.R. CARBON**

If you consider feeder fishing to catch many big carps your technique. then the Precision carp Feeder is definitely your rod and you cannot stay without it! It has been specifically designed to fish carpodromo. carp fisheries and big rivers. where carp are not only big but really great fighters. The Super High Resistance Carbon allows a casting power up to 120 g and a total reliability to face the big ones. The Precision Carp Feeder features two fibreglass tips and double leg SiC guides to magnify its fighting qualities. Natural cork handle.

Code	Length	C. Length	Sections	Action	C.W.	Guides
152-41-360	3.60 / 12'	126	3+2	H	120	SiC
152-41-390	3.90 / 13'	134	3+2	H	120	SiC

\*Spare tip set code 152-41-360-R01

## PRECISION XT RIVER FEEDER

**Power Joint**  **S.H.M.R. CARBON**

This new series can be defined "allround for extreme situations". They are perfectly calibrated for fishing in fast flowing rivers and canals. The progressive power action is maximized by the great power reserve in the butt section. being able to stop the big fish who is trying to escape in the middle of the stream. It is the perfect rod for barbell fishing with up to 150g feeders and still you can use in more quite situations. In Southern Europe they are used to fish from piers and beaches to catch gilt-head bream. The Precision River Feeder has two tips, both in fibreglass, to match different situations. The equipment is completed by SiC guides and natural cork handle.

Code	Length	C. Length	Sections	Action	C.W.	Guides
152-42-360	3.60 / 12'	126	3+2	HH	150	SiC
152-42-390	3.90 / 13'	134	3+2	HH	150	SiC

\*Spare tip set code 152-42-360-R01



Maurizio Biolcati

## PRECISION XT FEEDER PLUS



FEATURES: \_\_\_\_\_

Powerful but balanced progressive rod made of Super High Modulus Carbon. We want to highlight the excellent casting performance of this new model: it really casts further and more accurately. We can define this rod a value for money rod. but you should not think this is a second category rod. Actually all the components we used to equip it is as good as those we use for more expensive rods: SiC guides. extra smooth for braided use too. EVA ergonomic handle and double super sensitive fibreglass tips.



These rods are all supplied with 2 interchangeable fiberglass quiver tips with different actions.



Double leg SiC guides.



All the rods are equipped with Hookholder.

Code	Length	C. Length	Sections	Action	C.W.	Guides
152-43-360	3.60 / 12'	126	3+2	MH	90	SiC
152-43-365	3.90 / 13'	126	3+2	H	120	SiC

\*Spare tip set code 152-43-360-R01



## PRECISION XT COMBI TIP



A modern match & feeder rod which allows the pleasure anglers to switch from feeder to waggler in case fish move up in the water to look for warmer temperature. It happens so often in the commercial lakes. specially during summer season. and in such cases a single rod like this can brilliantly do the job. This is possible thanks to the twin top section supplied with new Precision XT: one is the classic feeder top. carrying two different quiver tips (both fiberglass made 1 oz Medium and 2 oz. Heavy) and the other is a tubular type. powerful match top able to deal with wagglers and pellet wagglers up to 25 grams weight. The rod handle is proving how much Trabucco development team pays attention to functional details. An EVA fore grip for comfort and easy cleaning of reel seat area. then natural cork with hot printed logo. then a rubber butt grip ending with soft. rounded cap so useful during those long fights with powerful carp.



Screw reel seat made from steel and rubber. Natural cork handle with special EVA butt grip. Feeder top section + 2 quiver tip; tubular Match top section.

Code	Length	C. Length	Sections	Action	C.W.	Guides
152-44-360	3.60 / 12'	125	3+3	MH	90	SiC

\*Spare quiver tip set code 152-44-360-R01S



## PRECISION XT SW FEEDER



Built with High Resistance carbon to bear any sort of stress, these rods can be heavily loaded to shoot heavy rigs at long distance. The big cage feeders can fly out where barbel, carp and catfish are waiting for food, while the rod is equally at home at sea side with closed end feeder packed with maggots to tempt the Mediterranean sea bream. The reliable overcap joints are further reinforced by crossed carbon bands without affecting the perfection of action curve. In order to suit the demand about naked handles, the rod shows separated rubber and EVA grips, with just blank in between. All the components have been carefully selected, with good quality double leg guides and sturdy screw reel seat to also accept big size reels. Two fibreglass quiver tips are included: Light, Heavy.



Code	Length	C. Length	Sections	Action	C.W.	Guides
152-46-360	3.60 / 12'	125	3+2	MH	90	SiC
152-46-390	3.90 / 13'	135	3+2	H	110	SiC



## NEW PRECISION SW SENSOR



It has been developed to integrate the lucky Precision XT SW Feeder series with a "sensor" action that allows to face more delicate fishing situations, both from the casting power point of view and from that of sensitivity. Three rods, with a fine 9 feet that can easily be used also from the boat, a 10 and a 11 feet with the same power, ideal for bomb and feeder as well. Thanks to High Resistance SHMR carbon blanks with reinforced joints, the resistance is granted, even in case of some mistreatment.

The handle is naked type, with grips in high density EVA. Double legs SiC guides, which become single legs on top section. Two interchangeable fibreglass quiver tips, with action Light (yellow) and Medium (red).

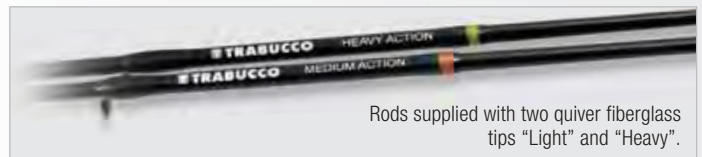

Rods supplied with two quiver fibreglass tips "Light" and "Heavy".

Code	Length	C. Length	Sections	Action	C.W.	Guides
152-47-270	2.70 / 9'	140	2+2	M	50 g	SiC
152-47-300	3.00 / 10'	105	3+2	M	70 g	SiC
152-47-330	3.30 / 11'	116	3+2	M	70 g	SiC

\*Spare tip set code 152-41-270/300/330-R01



Saverio Rosa





**NEW** ERION XS ALLROUND TELEFEEDER



Within the typically Italian passion for telescopic rods, there is room for a feeder rod. On top of the wish list there is the compact closed length, which eases the transportation of the rod; then comes the action, which should allow to fish almost everywhere, from the canal to the lake, up to the sea from rocks and piers, and even by boat. Erion XS solves all these problems with a reliable carbon structure and the two interchangeable fiberglass tips. The ergonomic reel seat is made from graphite, while the handle is rubberized for easy cleaning. Single leg guide's wrappings incorporate a protective o-ring.

Code	Length	C. Length	Sections	Action	C.W.	Guides
152-66-300	3.00 / 10'	99	5+2	Allround	10-60 g	SiC
152-66-330	3.30 / 11'	99	5+2	Allround	10-60 g	SiC
152-66-360	3.60 / 12'	99	5+2	Allround	10-60 g	SiC



Erion is supplied with two interchangeable fiberglass tips "Light" and "Heavy".

AIRTEK FLOATING FEEDER & BLACK HEAD



Find out more on page 323





The blanks is assembled using SHMR Carbon SiC guides double legs.

## SYGNUM XS BARBEL

~~Power Joint~~ S.H.M.R. CARBON

This rod, designed for a demanding, growing market, is a perfect rod for barbel fishing in all European waters. Supplied with 1.75 and 2.25lb tip sections, it adapts to different fishing situations. The special High Modulus Carbon used for every section grants both superior stiffness and lightness, and a beautiful look. Progressive action gives a

reserve of power to make it suitable even for very large prey. Equipped with Super S-SiC Light Frame guides, the latest design reel seat and natural cork handle.

Code	Length	C. Length	Sections	Action	Guides
151-44-360	3.60	185	2	1.75lbs	SiC

## QOSMIO FEEDER

4000 0.200mm/390m 0.250mm/250m 0.30mm/175m

6000 0.200mm/405m 0.300mm/315m 0.400mm/175m



- Micro-adjusting Front Drag With Oversized Washers
- CNC Machine Cut Aluminum Handle
- Soft Rubber Ergonomic Handle Knob

Find out more on page 173

## ERION XT SPECIMEN TWIN TIP



This Powerful rods has been designed for fishing big-sized fish without difficulty in either retrieval or landing. It is a perfect rod for barbell fishing in all European waters. The ERION TWIN TIP is not only a powerful rod but a Specimen rod too. This 12' rod is entirely built in Super High Modulus Durawall Carbon for both superior stiffness and lightness. The progressive action still leave a reserve of power to make it suitable even for very large prey. It comes with two tips 1.75 lb and 2.25 lb to satisfy all casting conditions and for fighting with different fish size, as often comes when fishing for carp, barbel or tench.



SiC guides double legs. The rod comes with two tips 1,75 lb and 2,25 lb.



Code	Length	C. Length	Sections	Action	Guides
152-68-360	3.60	186	1+2	1.75-2.25 lbs	SiC

## ERION XS POWER FEEDER



Special rod designed for barbel fishing. Barbel is one of the most powerful and widespread species in Europe and that's why so many anglers are focused on this fish. What the anglers ask is a super strong and reliable rod that is well balanced and not heavy. The Erion XS is exactly what they ask! The family includes three 3.90 models and this length is sufficient to keep your line out of the stream and avoiding your feeder to drift on the bottom. The Super High Modulus CX-1 Carbon blanks are strong but progressive, allowing to fight over

4 kilos big barbels with great amusement. The rod is finished with ergonomic cork and EVA handle. DPS reel seat able to host big pit reels and 3 tips. 1 solid glass and 2 solid carbon.



Rods equipped with 3 tips, 1 fiberglass and 2 carbon.

Code	Length	C. Length	Sections	Action	C.W.	Guides
152-67-390	3.90	138	3+3	H	150	S-SiC
152-67-393	3.90	138	3+3	HH	180	S-SiC
152-67-395	3.90	138	3+3	XH	230	S-SiC

## FEEDER HOOKS

**SUPER SPECIALIST** Perfect for hair rig presentation of pellet and sweetcorn on the bottom, it comes from a classic carp hook design, which has been modified at barb area, drastically reduced to micro size. The series has been developed to provide high levels of resistance even in small sizes such as 14 and 16, because today it is increasingly common to tempt big fish with tiny bait, in the commercial circuit but also in the open waters.

**XS SPECIMEN** The symbol identifying this series can be read under double meaning: "extra strong" as super-rugged, but also "excess" as exaggeration. Either way, a nice program in any fishing situation involving high stress and extreme pulls, because exceeding in the resistance never hurts. The forged bend is ready to bear everything, strictly cooperating with the high, beaked point.



Find out more on page 240





# LAKE TROUT RODS

Why spend more when you get a chance to find a higher quality rod at a lower price? This is a question that many anglers should ask, especially in lake trout fishing. Trabucco this year offers a great opportunity to all enthusiasts anglers of this unique opportunity: the ability to buy advanced technology and quality products at a lower market price. Before buying any trout rods please compare it to a Trabucco one, close your eyes and try to feel the differences ... At that point you will notice that the only difference is the price because our is the best one in the market. Use your brain, if you know fishing you choose Trabucco.

## DREAM TEAM LAKE TROUT



Top of the range series with Super Slim design which gives a nice handling to all rods, including the powerful 44LD. This specification comes from lake trout's competition world, as well as the spliced top section, which is vital to detect fish bites, specially when trout are particularly shy. The wonderful lightness and the outstanding strength of Dream Team XPS rods is due to CX2 carbon construction, in which the bonding agent is a nano-tech resin that can be evenly dispersed between layers, even in limited quantity. Guide's configuration is well designed, with "Y" frame guides to avoid vibrations and small diameters to get a nice flow of the line; wrappings show hi-class quality, and include coloured yarn to match action colour Code bands visible on butt section of each rod. The series is wide enough to equip the demanding angler and let him face all weather conditions, in the small lakes as well as the big and deep ones located up north.



### FEATURES:



Plate reel seat, finely wrapped. Ultralight butt cap directly screwed into the carbon wall.

Code	Length	C. Length	Weight	Sections	Action	C.W.	Guides
124-28-100	3.90	118	110	7	UL	1-3	SiC
124-28-200	3.90	118	130	7	L	2-5	SiC
124-28-300	3.90	118	140	7	LL	3-8	SiC
124-28-400	4.00	128	160	7	ML	4-10	SiC
124-28-500	4.20	128	170	5	M	8-15	SiC
124-28-600	4.30	132	190	5	MH	12-20	SiC
124-28-700	4.50	132	200	5	MHS	15-30	SiC

## ASTORE PRO LAKE TROUT



Lightweight, strong and balanced: these are the characteristics for a tremarella/bombard rod. And the more you can get in these three categories, the more these rods are appreciated among the competitors. So to obtain such a brilliant result we decided to design each action independently from the others, trying to optimize the power curve removing as much sliding guides as possible. The result has been achieved by opting for seven sections blanks for actions from 1 to 4 and five sections for the actions 5 to 7. The carbon used could not be other than super high modulus CX-2, the only one that has the characteristics of perfect transmission of vibrations and yet so strong and lightweight. Also, to further increase the sensitivity of the rod, the reel-seat has been integrated in the butt section. SiC guides allow the safe use of smaller lines without the



Super Slim blank made from CX2 Nano-Tek carbon. The rods are equipped with Hookholder. Medium leg guides with "Y" shaped frame (SiC ring).



Action colour Coded wrappings.

SS SUPER SLIM BLANK SENSi TOUCH CX2 CARBON NANO-TEK



risk of overheat caused by friction. Every action is characterized by a band of different color on butt section.

Code	Length	C. Length	Weight	Sections	Action	C.W.	Guides
124-17-200	4.20	135	152	7	L	2-6	SiC
124-17-300	4.20	135	162	7	LL	3-8	SiC
124-17-400	4.20	135	164	7	ML	4-10	SiC
124-17-500	4.30	138	172	7	M	6-12	SiC
124-17-600	4.50	145	220	7	MH	8-15	SiC
124-17-700	4.60	150	232	7	MHS	12-20	SiC



## ATTRACTIVE PRO LAKE TROUT



An innovative solution applied to handle area gives these rods a real plus in term of comfort. It's the rubber shrink tube which dresses the bottom half of butt section, also providing easy cleaning and protection from scratch due to rod rack tubes. The fast tapered blanks are quite firm, with little or no oscillation after the cast, a common problem which can visibly reduce the distances. The great precision of action curves is perfectly followed by the mainline, thanks to the sliding guides carefully wrapped on to carbon pipes. Attractive Pro series is made of six actions, well spaced each other, and offer the

match angler the chance to buy twin rods without spending a fortune, because prices have been targeted with great care since the very start of the project.

Code	Length	C. Length	Weight	Sections	Action	C.W.	Guides
124-29-100	3.90	110	170	7	UL	1-4	SiC
124-29-200	3.90	115	172	7	L	2-6	SiC
124-29-300	3.90	110	174	7	LL	3-8	SiC
124-29-400	4.00	110	185	7	ML	4-12	SiC
124-29-500	4.10	125	205	7	M	8-15	SiC
124-29-600	4.40	125	237	6	MH	12-25	SiC



## NEW ACTIVA SLIM TROUT



A complete and modern series by all means. First of all, the right lengths: no rods under four meters to follow the long hooklink's trend. Secondly, the super slim profile, currently the most required, accompanied by solid carbon tips for the highest sensitivity. Finally, parabolic and super-parabolic actions, nowadays essential, and a sign of attention to the matchman's needs: just above the reel seat a window to write down

by permanent marker the rig's specifications, such as the sinker's weight, its swimming attitude, the hook's size and hooklink's diameter. The SiC guides have the vibration free "Y" shaped frame, while the sliding ones fit into each other to protect the rod tip during transport. A package of features and performances offered at the right price, to allow everyone to face the lake trout competitions without investing a fortune, thus having spare financial resources to also buy Trabucco reels!



Just above the reel seat, the INFO window enables to write down rig's details by a permanent marker, which at the end of the match can be deleted by alcohol.

Code	Length	C. Length	Weight	Sections	Action	C.W.	Guides
124-33-100	4.00	128	160	7	ULLS	0-3	SiC
124-33-200	4.00	128	160	7	ULS	1-4	SiC
124-33-300	4.00	128	160	7	UL	2-6	SiC
124-33-400	4.00	128	165	7	LL	3-8	SiC
124-33-500	4.00	128	170	7	LL	4-10	SiC
124-33-600	4.10	128	180	7	ML	6-15	SiC
124-33-700	4.30	128	195	7	ML	10-20	SiC
124-33-800	4.30	128	210	7	MH	15-30	SiC

## ERION XPWR LAKE TROUT



This series is particularly indicated for those small lakes which are so common all over Europe, where the rod's power is not destined to cast at range, but it's useful to lift trout from water at speedy rate. In fact, all five rods in the series have been designed around same length - namely 4 metres - and stand out for their compact closed length and slim handle diameters. The solid carbon tip, responsible of the neat bite indication, is fitted on second section via telescopic joint, a simple but effective solution at the same time. On top of each section, there is a crossed reinforcement made from an orthogonal carbon band; it is there to protect joints from heavy loads which could

cause breakages. Such solution makes Erion able to bear the inevitable stress due to newcomer's rawness.



Code	Length	C. Length	Weight	Sections	Action	C.W.	Guides
124-31-100	4.00	85	150	8	L	2-6	S-SiC
124-31-200	4.00	85	160	8	ML	4-8	S-SiC
124-31-300	4.00	86	170	8	M	6-12	S-SiC
124-31-400	4.00	87	190	8	MH	10-20	S-SiC
124-31-500	4.00	87	200	8	H	15-30	S-SiC



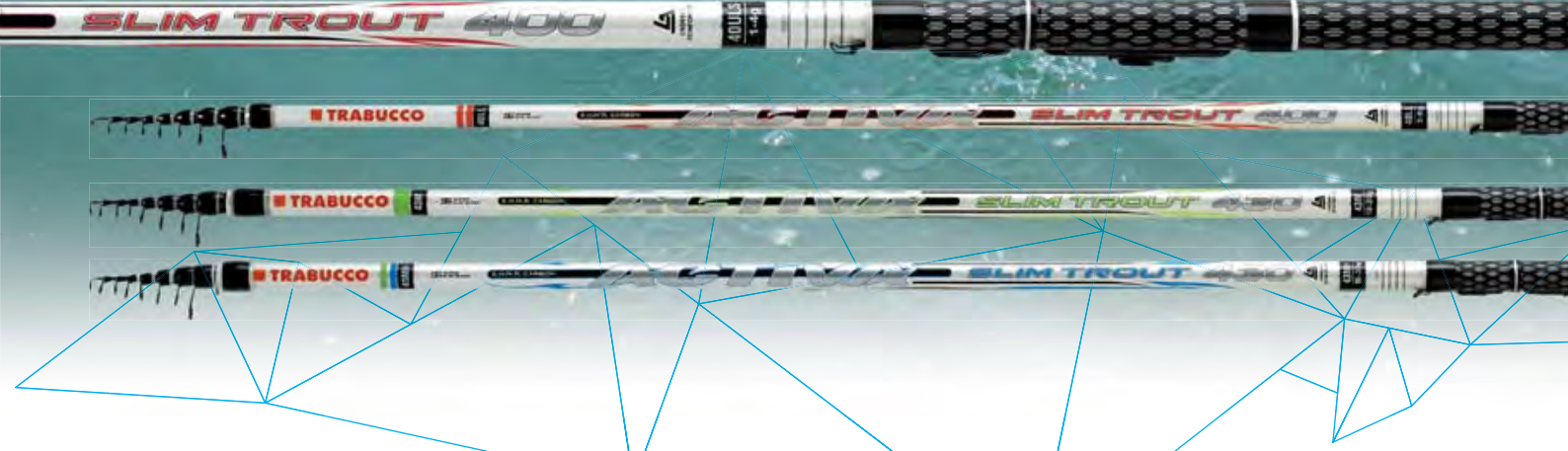

**NEW** REVENTON vx LAKE

-  **SENSI TOUCH**
-  **ULTRA CONIC BLANKS**
-  **CROSSED REINFORCED**
-  **high precision control**
-  **S.H.M.R. CARBON**

The cheapest of Trabucco lake trout rods can surprise more than a few expert anglers for the amount of technical specifications which have been put in this project. Firstly, the remarkable taper gives the rod a perfect balance and allows the newcomer to experience good casts. Secondly, as soon as the retrieve starts, any message coming from the hookbait is clearly sent to the user, even in case of shy bites. Thirdly, the production has been run under strict quality control, so that all telescopic joints are fitting perfectly, with great advantage in term of sensitivity and strength. The medium leg guides have been carefully chosen in order to avoid any excess of weight and leave the blank maximum freedom.



Code	Length	C. Length	Weight	Sections	Action	C.W.	Guides
124-32-500	3.90	130	190	6	L	2-6	S-SiC
124-32-600	3.90	130	190	6	ML	4-10	S-SiC
124-32-700	4.10	130	200	6	M	6-15	S-SiC
124-32-800	4.20	130	210	6	MH	10-20	S-SiC



## ASTORE TX BOLO

Adjustable rod series designed for river trout fishing, built in Super High Modulus Radial Carbon Technology in 4-5-6 and 7m lengths. Extremely light but robust and reliable, this rod is also recommended for other fishing techniques requiring a very stiff and strong rod, such as salt water fishing and bolognese with heavy floats. Equipped with Super S-Sic guides and amortized reel seat. A unique fishing rod, easy to use. It will be appreciated mainly by expert anglers.

MULTI LENGTH SYSTEM

SENSI TOUCH

CX2 CARBON NANO-TEK



Code	Length	C. Length	Wt	Sections	Guides
124-45-500	4.00 - 5.00	147	260	5	SiC
124-45-600	4.00 - 5.00 - 6.00	150	345	6	SiC



## VANADIA XT-MATCH

Rods which show an impressive Super Slim butt, considering the tremendous power it can deliver, with a slightly upper reel seat which is there to help you push as much as you like. The body of these rods is engineered to be heavily loaded, thus boost heavy bombardas to the horizon. The job is done by CX-1 Micro Pitch carbon, whose structure is so tight that the blank's answer is strong and neat, without oscillations. The blank is further powered and protected by a cross winding carbon yarn, which is purposely missing on top section to generate a perfect action curve. Guides are short leg HD model, able to quickly disperse heat caused by the endless line flow, an essential part of lake trout fishing.

CV CROSS WINDING

SENSI TOUCH

SS SUPER SLIM BLANK

CX1 CARBON MICRO-PITCH

Code	Length	C. Length	Wt	Sections	C.W.	Guides
150-34-450	4.50	130	202	7	10-60	SiC
150-34-455	4.50	130	208	7	20-80	SiC

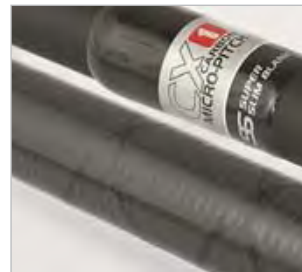

Blanks made from Micro Pitch Carbon CX-1 (Super Slim).



Medium leg HD guides (quick heat dissipation).

## SLURP & YUMMY BAIT

Honey worm, earthworm and some other larvae are the most common natural bait used in lake trout fishing. But they bring at least three disadvantages. First of all, they suffer high temperatures, and day after day their efficiency fades sharply. Secondly, they can't resist to trout's crunch, as they tear them. Consequently, they must be replaced after each trout landed, otherwise the bite's rate slows down, and maybe some bites are easily missed. Finally, with natural worms the correct hooking operation can be difficult, and to improve the hook position the angler has no other choice but to replace the bait. All these problems have been successfully solved by Trabucco with his own fantastic Yummy and Slurp artificial bait, which offer endless solutions in term of silhouette, size, texture, taste, colour and scent, up to helping the hook-bait's rotation through computer designed shapes.



Find out more on page 352

# BLACK HT BOMBARDAS

*Developed and engineered by Trabucco team for lake trout competition.*

Developed and engineered by Trabucco team for lake trout competition, these bombardas are made from EVA, a material which is known for the resistance to shocks and for its elasticity against compression. But there is something more, because the artificial nature of this material offer a consistent buoyancy, due to the even distribution of the air bubbles throughout the volume. Consequently, their behaviour in action is very much stable from one piece to another, and also during its life. In water, they sink according to four different plans and keep an almost horizontal attitude during the retrieve. That's important to ensure that the hookbait travels at regular depth, as well as offering the highest sensitivity. The action displayed in water depends from weight and position of brass stabilizers, which are placed in the heart of the body. The tubular stem is made from high strength plastic and is coloured to allow quick identification of each model.



## BLACK HT SUPERFICIE



The extra weight in the range of 1-3 grams makes it useful to fish in the first meter below water's edge. Ideal for winter fishing with quick retrieve and extra long hooklinks, even beyond the 2 metres mark.

Code	Weight (g)	Extra Weight
017-00-060	6	1.0
017-00-080	8	1.5
017-00-100	10	1.5
017-00-120	12	2.0
017-00-150	15	2.0
017-00-200	20	2.0
017-00-250	25	3.0

## BLACK HT MEZZO FONDO



Its name tells that it works wonder in mid-water with slow retrieve, but its weight pattern enables to also operate at higher speed during autumn and winter. Long hooklinks are recommended.

Code	Weight (g)	Extra Weight
017-01-060	6	1.5
017-01-080	8	2.5
017-01-100	10	3.0
017-01-120	12	3.5
017-01-150	15	3.5
017-01-200	20	4.0
017-01-250	25	4.0

## BLACK HT FONDO

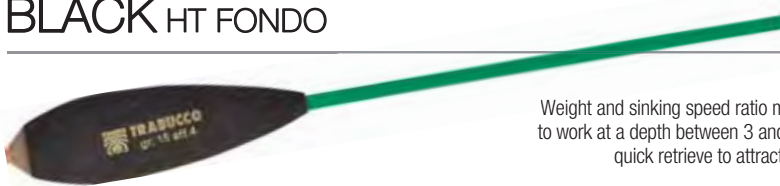

Weight and sinking speed ratio make this bombarda perfect to work at a depth between 3 and 6 metres, with a relatively quick retrieve to attract the most aggressive trout.

Code	Weight (g)	Extra Weight
017-02-060	6	3.0
017-02-080	8	4.0
017-02-100	10	5.0
017-02-120	12	6.0
017-02-150	15	6.0
017-02-200	20	7.0
017-02-250	25	7.0

## BLACK HT BUGIARDINO



It's the quickest sinker in the range, and once down it keeps an ideal route at least around 8-10 metres of depth and more. Therefore, summer is the season when it gives the best with aggressive retrieve.

Code	Weight (g)	Extra Weight
017-03-060	6	3.0
017-03-080	8	4.0
017-03-100	10	5.0
017-03-120	12	6.0
017-03-150	15	8.0
017-03-200	20	10.0
017-03-250	25	12.0

BLACK HT BOMBARDAS - Swimming attitude

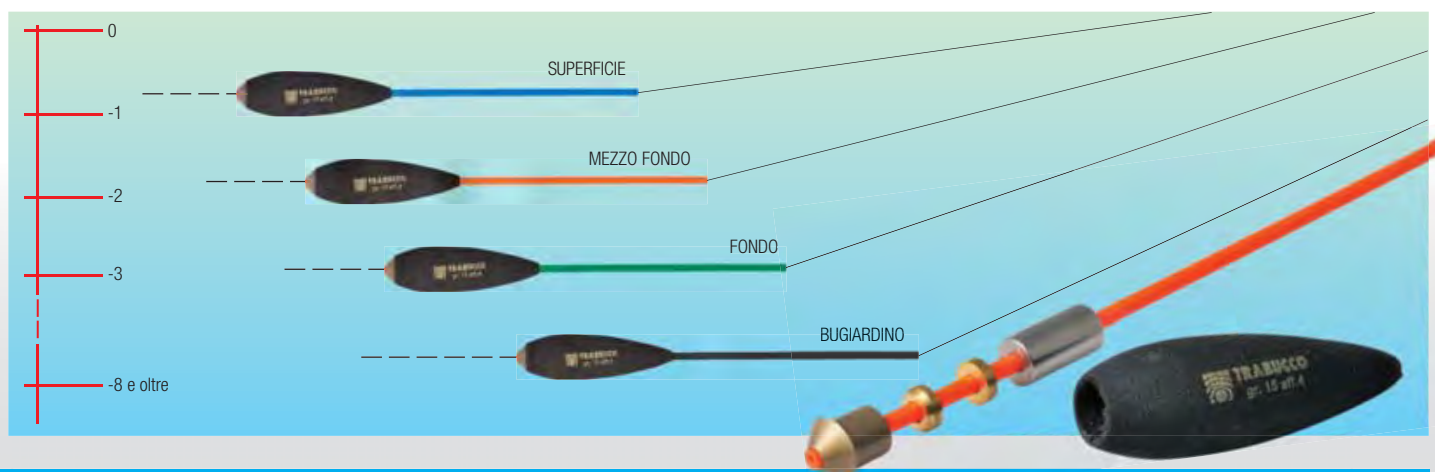

### SHORT TUBE

The classic lead sinker, good in most conditions. It sinks slower than the short model. Bag of 5 pieces including rubber tube.

### SLIM TUBE

Ultra thin and long, this lead sinks very slowly, so it's perfect for surface work. Bag of 5 pieces including rubber tube.

### SUPER SLIM TUBE

A micro version of Slim Tub model, developed to create strings useful with wary trout. Bag of 5 pieces including rubber tube.

### MICRO SLIM

Trout lead sinker with compact body, ideal for speed fishing or to swim close to the bottom. Bag of 5 pieces including rubber tube.

### MICRO SFERE

Compact shape means higher sinking speed. Developed for medium speed surface work or slow retrieve close to the bottom. Bag of 5 pieces including rubber tube.



Code	Weight (g)
090-83-020	2,00
090-83-025	2,50
090-83-030	3,00
090-83-035	3,50
090-83-040	4,00
090-83-045	4,50
090-83-050	5,00

Code	Weight (g)
090-80-020	2,00
090-80-025	2,50
090-80-030	3,00
090-80-035	3,50
090-80-040	4,00
090-80-045	4,50
090-80-050	5,00
090-80-060	6,00

Code	Weight (g)
090-81-010	1,00
090-81-015	1,50
090-81-020	2,00
090-81-025	2,50
090-81-030	3,00
090-81-035	3,50
090-81-040	4,00

Code	Weight (g)
090-82-002	0,20
090-82-003	0,30
090-82-004	0,40
090-82-005	0,50
090-82-007	0,70
090-82-010	1,00
090-82-015	1,50

Code	Weight (g)
090-84-001	0,10
090-84-002	0,20
090-84-003	0,30
090-84-004	0,40
090-84-005	0,50
090-84-007	0,70
090-84-010	1,00

### PLASTIC OLIVE



It is typically used in trout lake fishing to calibrate the float or themselves to "Saltarello". Recommended for clear waters when targeting very suspicious fish.

Code	Weight (g)	Pcs
013-97-002	2,0	5
013-97-003	3,0	5
013-97-004	4,0	5

### VETRINI TROUT GHOST



Clear glass tubular sinkers for lake trout fishing at close distance. Available in bags of 3 or 4 pieces depending on size.

Code	Weight (g)	Pcs
013-95-002	2,0	4
013-95-003	3,0	4
013-95-004	4,0	4
013-95-006	6,0	3
013-95-008	8,0	3

### VETRINI IRIDIUM PIOMBATI

Small plastic sinkers. Compared to glass models, these sink slower and allow the angler to search the fish in a very shallow depth, even at short distance.

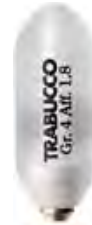

Code	Weight (g)	Extra Weight
017-70-020	2,0	1,4
017-70-030	3,0	1,7
017-70-040	4,0	1,9
017-70-050	5,0	2,1
017-70-060	6,0	2,3

## SWIVELS & RUBBER STOPPERS

In order to get the best from bombardas, lead and glass sinkers, Trabucco range offers some excellent accessories.

The double and triple swivels belonging to Power Swivel assortment are perfect to download the inevitable torsion generated during the retrieve, because the hookbait spins quickly. Beyond the traditional swivels with connected eyes or multiple bodies, the HS Rolling Special is quite interesting because it offers a quick change clip to replace the hooklink instantaneously. We recommend to insert a segment of silicone tube on to the hooklink, before forming the loop. Once the loop has been connected to the swivel's clip, the tube locks everything. Please take care not to cover the clip's mouth with the tube.

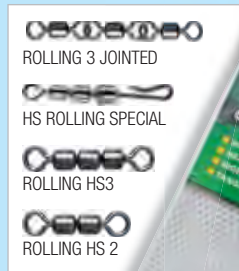

The knot connecting swivel to mainline is subject to hard stress due to bombardas weight, so it's highly recommended to protect it with an Oval Rubber Stopper from Competition range, available in four sizes.



Find out more on page 349

### BOMBARDA IRIIDIUM ZERO GRAVITY

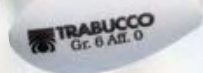

White colour Bombarda, made of unbreakable plastic material. It is floating and allow to fish on surface, both with a retrieve or still action. This particular Bombarda can be used also in those competition in which the surface fishing is not allowed.

Code	Wt (g)	Extra Weight
017-45-040	4	0
017-45-060	6	0
017-45-080	8	0
017-45-100	10	0
017-45-150	15	0
017-45-200	20	0
017-45-300	30	0

### BOMBARDA IRIIDIUM PRO LIGHT



Satinated colour Bombarda, made of plastic material. Due the use of one only construction material the sinking capacity is guaranteed. The sinking grades are very small, in order to allow the angler to search trout on surface or mid depth.

Code	Wt (g)	Extra Weight
017-65-040	4	0.8
017-65-060	6	1.2
017-65-080	8	1.6
017-65-100	10	2.0
017-65-150	15	3.0
017-65-200	20	4.0

### LONG CAST SPHIROLETTE



Long Cast Spirolette represent the good solution to cast at long range any light lure or bait, as it often happens in lake trout fishing. Can also find good use at sea with grubs or to cast lightweight baits.

Code	Wt (g)
013-96-010/10	10
013-96-015/10	15
013-96-020/10	20

### AQUA BOMB



Water filled Bombarda, entirely made by transparent polycarbonate. It is possible to obtain a casting and floating weight by filling more or less the Aquabomb with water. Suggested for lake trout fishing and as well in sea, as a classic "buldo".

Code	Wt (g)
015-60-050/10	5
015-60-080/10	8
015-60-100/10	10

### T-FORCE XPS TROUT



This transparent monofilament is dedicated to all the people who loves fishing for trout in lakes or fisheries. Its color makes it perfect for use especially in chrystal clear water. The special manufacturing procedure used makes it extremely resistant to twisting and the extremely smooth surface allows to reach incredible casting distance even using lightweight lures or rigs. Available in five different diameters on 150 meters spool.

Find out more on page199

### PENNA TROTA

Straight peacock designed for trout fishing. Both ends are fluo painted to be reversed according to light conditions.

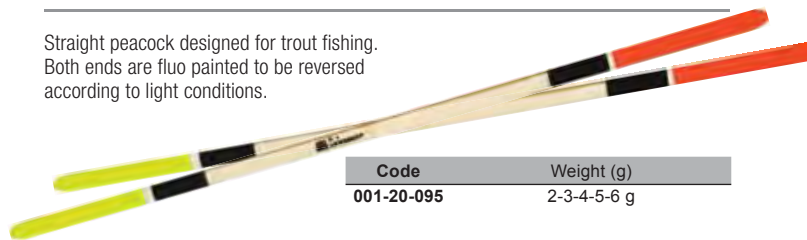

Code	Weight (g)
001-20-095	2-3-4-5-6 g

### STRIKE INLINE

Short dibber float with fluo top and line running through the body. Designed for shallow and running waters, it's just awesome for trout fishing in small rivers.



Code	Stem	Weight (g)
001-20-100	Carbonio	1.00 - 2.00 - 3.00 - 4.00 - 5.00

### ZOOM IN LINE

Elongated dibber float, with fluo top, line running through the body and bushed top. Designed for lake trout, it can be well employed also for other species.



Code	Stem	Weight (g)
001-20-090	Carbonio	2.00 - 3.00 - 4.00 - 5.00 - 6.00



## RIVER TROUT RODS

*When you fish trouts in rivers you often need a good strength and very good fishing tackles. We can provide you the correct adjustable rods, just perfect for this technique: light, stiff and power-*

*ful. In our catalogue you will find rods for super specialists, competition anglers and passionate anglers, that need short sections rods.*



## DREAM TEAM XPS RIVER TROUT



The top rod of our range is now the Dream Team Trabucco XPS River, a science fiction 10 meters of unsurpassed performance. Its excellence comes from the wise use of the best super high modulus carbon Nano-Tek CX-2 and from the specific design of each section. A judicious lay of the carbon fibers, both linear and radial, that varies in each element in order to have always and in any case the maximum performance. The encumbrance of the blank has been reduced to the minimum in order to allow easy transport and an easier handling, without thereby affect the fishing action, which turns out to be very strong and stiff and therefore makes possible to detect the most shy and wary bites. The strike is always ready, rapid and inexorable, a sort of shot that we guarantee to surprise the trout and firmly pierce its mouth with the hook. The blocks are made using the shrink tube, extremely versatile, reliable and lightweight. Single legged SiC guides allows you to use thinner monofilaments without harming it with the heat of friction, avoiding to deteriorate their technical qualities and prolonging their life.



Davide Ricotti



Code	Length	C. Length	Weight	Sections	Guides
124-49-100	10.00	160	499	8	SiC



## ASTORE TX RIVER TROUT



Fishing for trout in rivers requires rods with very high specs, if only to attend the rigidity and lightness required. The Astore TX Trout River is built in CX-2 Nano-Tek Carbon, a super high modulus carbon that is unrivalled in reliability, rigidity, break resistance and lightness. The lower sections, those of greater diameter, have been designed to be just slightly tapered to allow the use of the shrink tube for the realization of the adjustable blocks, saving precious grams on the total weight which remains therefore not only restrained but also exceptionally well-arranged and thus balanced. Single foot SiC guides provide an excellent smoothness to the monofilament in every condition.



Code	Length	C. Length	Weight	Sections	Guides
124-43-700	7.00	140	308	SIC	7
124-43-800	8.00	146	403	SIC	8





## ATTRACTIVE TRL RIVER TROUT

MULTI LENGTH SYSTEM

SENSI TOUCH

CROSSED REINFORCED

high precision control

CX-1 CARBON



Maximum reactivity of the blank with a particular attention to the control of the fish. This was our target, but not only: we wanted a stiff rod (very stiff), light and with a slim blank. Thanks to the CX-1 High Modulus carbon the result is exciting, the rod is very light and very well balanced, but what surprises most is the stiffness ... it seems only the tip is bending. We really like this rod, ask your dealer to let you try and then compare it to any other rod in this price range, you will see that the value for money is unbeatable.



Code	Length	C. Length	Weight	Sections	Guides
124-44-500	5.00	135	285	5	SiC

## SYNTIUM TRL RIVER TROUT

MULTI LENGTH SYSTEM

SENSI TOUCH

CROSSED REINFORCED

CARBON S.H.M. DURAWALL



Practical and effective short butt section adjustable rod, stiff and powerful. Reliable in any situation, the blank is made from super high modulus radial carbon, light-weight but extremely strong and durable. A crossed carbon yarn has been added as reinforcement in the most stressed parts to enhance its stiffness and to allow to directly lift the prey. Short leg S-SiC guides complete the features of this interesting rod.

Code	Length	C. Length	Weight	Sections	Guides
124-79-500	5.00	125	206	5	S-SiC
124-79-600	6.00	137	440	6	S-SiC

## ASTORE TX BOLO

MULTI LENGTH SYSTEM SENSi TOUCH CX2 CARBON NANO-TEK



A very stiff bolognese rod, but still slim, light weighted and well balanced. Designed to strike the prey and tearing it off the water quickly, without disturbing the fishing area. The tip is extremely sensitive and fast and can stop the fish run anticipating its reactions. The ability to adjust the length according to the fishing needs is a huge tactical advantage, but what impresses most is how this rod rules the fish. A fishing rod easy to use that will be appreciated mainly by expert anglers.



Code	Length	C. Length	Weight	Sections	Guides
124-45-500	4.00 - 5.00	145	187	5	SiC
124-45-600	4.00 - 5.00 - 6.00	150	280	6	SiC
124-45-700	4.00 - 5.00 - 6.00 - 7.00	150	340	7	SiC

## NEW ATTRACTIVE MINI BOLO

CX-1 CARBON high precision control

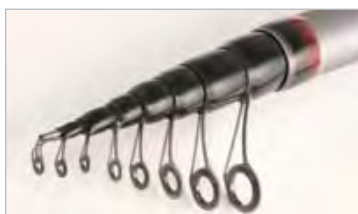

Series born from a very clever and complicated project, which led to the creation of three rods having identical closed length, a feature which is not so common in the world of compact bolos. The presence of long rods, such as 4,50 and 5 meters, makes even more interesting this series,

which is wrapped to perfection with lightweight long leg SiC guides. The section's taper has been designed to develop a fast action and, at the same time, obtain a truly short set of guides. All sections are finished with a special anti-stick paint, which eases the execution of long casts, even in presence of high humidity.

Code	Length	C. Length	Weight	Sections	Guides
124-82-400	4.00	70	150	8	SiC
124-82-450	4.50	70	190	9	SiC
124-82-500	5.00	70	230	10	SiC

## ERION XS MINI BOLO

SENSi TOUCH CX-1 CARBON



Let's face it: a handy and compact rod, you can leave in the car and that is not only easy to use but first of all reliable, it is a rod that is interesting for everybody. So this is not a rod for specialists but a rod which finds its use in the stream as in the pond, river or at sea. The high resistance carbon is a guarantee of total reliability, forgiving the mistakes of beginners, but also guarantees lightness and precision. The ringing S-SiC quickly disperses the heat, and allows the safe use of even very thin monofilaments.

Code	Length	C. Length	Weight	Sections	Guides
124-83-320	3.20	63	120	7	SiC
124-83-360	3.60	64	150	8	SiC
124-83-400	4.00	66	190	9	SiC
124-84-340	3.40	65	160	7	SiC
124-84-380	3.80	66	185	8	SiC

## NEW SYNTIUM FX

SENSi TOUCH CROSSED REINFORCED high precision control



These rods are made using a new procedure which allows the combination of H.R. Carbon and Powerfibre. Easy to transport, these rods can be used for trout fishing in reservoirs and streams, even with heavy rigs. The Syntium FX is really versatile and if necessary can be used as Bolognese when fishing for carp. All the rods are equipped with S-SiC guides and premium quality reel seat.

Code	Length	C. Length	Weight	Sections	Guides
124-74-300	3.00	72	145	5	S-SiC
124-74-350	3.50	74	195	6	S-SiC
124-74-400	4.00	77	245	7	S-SiC

# CARP & SPECIMEN

Target Big Fish! The direct confrontation and catching the fish is the objective pursued by those who practice these fishing techniques. We know this and our wide range of products is made to cover the needs with the proper rods: with the sole purpose of catching a powerful large fish! Considering that there are people who fish in large rivers and people who just fish in commercial fisheries, people who prefers the powerful two-piece, other who prefers three pieces and finally considering telescopic rod fans... we propose a complete range, from more specialist rods to the most versatile ones, so we are confident that you will surely find in these pages the rod for you. Certainly you will not find anywhere else such a value for money rods.



Nicolae Ursachi Trabucco Canada

## LEGEND CARP X2

S.H.M.R.  
CARBON

Full high resistance carbon rod made in 2 sections. The overall look is dramatic thanks to the first class woven carbon finishing. The progressive action is outstanding for the price, powerful when casting and yet enough soft to manage the carp during the fight. Best components has been used to finish the rod, using double leg SiC guides, ergonomic screw reel seat and EVA handle.

Code	Length	C. Length	Sections	Test lbs	Guides
156-37-360	3.60	188	2	3.00	SiC



## LEGEND CARP X3

S.H.M.R.  
CARBON

3 sections rod fully built in high resistance carbon with classic action. The blank has a great power reserve, so to make it so similar to a more common 2 pieces carp rod. The 3 pieces construction will help during the transport. It is an easy to use rod, reliable and very enjoyable. It is equipped with double legs SiC guides, screw reel seat and EVA handle.

Code	Length	C. Length	Sections	Test lbs	Guides
156-38-360	3.60	125	3	3.00	SiC

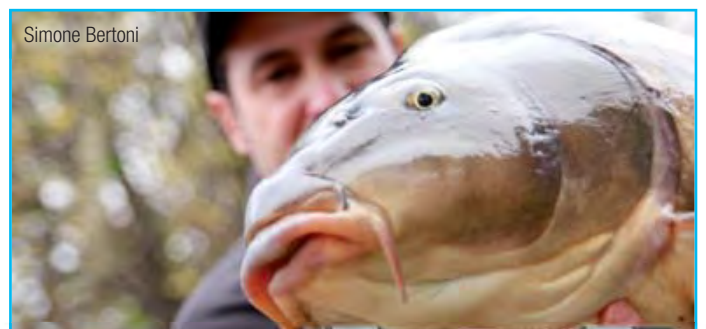



# KKARP

*Inspire the next*

## KKARP FISHING

*Well known and established, K-Karp is the only Italian brand to offer all the necessary equipment for Carp Fishing. A special, exclusive dedication to the technique inspire the team that develops every single product: during the authentic fishing sessions the ideas come up, practical problems are faced and solutions are created, then made available to all.*

*Starting from what comes in direct contact with the carp, that's the hook and small components for the hookbait's presentation, to switch to the hooklinks and leads, to the lines, reels, rods, rod pods and bite indicators, everything is configured to cooperate.*

*K-Karp also offers a range of accessories for the angler's comfort: clothing, luggage, bivvies, chairs and bedchairs. Particular attention is paid to the fish welfare, with landing nets, unhooking mats, carp sacks, all designed in respect of his safety.*

*Visit [www.kkarp.com](http://www.kkarp.com) and ask your dealer for the specific catalog.*





## CYCLONE

S.H.M.R.  
CARBON

Three pieces carp rod made using H.R. Carbon. Thanks to the new construction procedure this rod will surprise you for the perfect fast-parabolic action. Easy to carry and transport, this rod can be used in many situations. Equipped with first choice EVA handle and double leg SIC guides.

Code	Length	C. Length	Sections	Test lbs	Guides
156-31-360	3.60	188	2	3.00lb	SIC

## CYCLONE X3

S.H.M.R.  
CARBON

Three pieces carp rod made using H.R. Carbon. Thanks to the new construction procedure this rod will surprise you for the perfect fast-parabolic action. Easy to carry and transport, this rod can be used in many situations. Equipped with first choice EVA handle and double leg SIC guides.



Code	Length	C. Length	Sections	Test lbs	Guides
156-32-360	3.60	125	3	3.00lb	SIC

## THUNDER

S.H.M.R.  
CARBON



If you are looking for a good carp rod, made from carbon and at an affordable price, stop here! The Thunder has been entirely made from high resistance carbon and features a classic progressive action, being able to cast well and to manage the retrieve of a big carp with no problems. Equipped with double legs S-SiC guides to allow you to use braided lines.

Code	Length	C. Length	Sections	Test lbs	Guides
156-39-360	3.60	188	2	3.00	SIC
156-39-390	3.90	195	2	3.00	SIC



## MAXXIS MONSTER

**Power Joint** **CX-1 CARBON**



We spent many hours on the river to test our new MAXXIS MONSTER fighting with huge catfish. Simply perfect to be used from the boat and for lure fishing from the shore, these rods revealed enormous power and progressive action which helps to rule even the toughest fish in extreme conditions. The blanks are built using full CX-1 Carbon and are equipped with double leg SIC guides. This rod is perfect to be used with braided lines and features the virtually unbreakable Magic Stick Tip. Ergonomic handle wrapped in premium quality EVA delivers the maximum comfort and grip in any situations.

Code	Length	C. Length	Sections	C.W.	Guides
157-31-210	2.10	108	2	150	SiC
157-31-215	2.10	108	2	300	SiC

# CATGEAR

*With its remarkable fighting power and unexpected speed when attacking target fish, the Catfish has conquered important spaces in the Italian and European sport fishing, up to give life to a new generation of specialist anglers. The Catgear range is dedicated to them, with a complete assortment of tackle and accessories born from direct experiences. Rods for the bank or boat fishing, lines, swivels, hooks and accessories, clothing and luggage are united by young and brilliant cosmetics, identified by the contrast of yellow and black colours. The attractive graphics created the brand identity, but it has been the total product reliability to give it the highest possible image, which has brought Catgear into the exclusive club of leaders.*

Ask your dealer for the specific catalog.

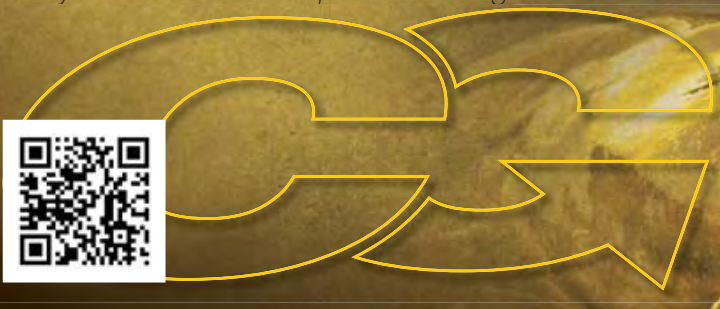



## NEW REVENTON ALLROUND SLIM

Although fishing is going through an era of great specialization, with tackle more and more designed to face a single fishing technique, there is still a strong demand about allround rods, to be kept in the car's booth just in case. Compact closed length, reliability and good casting power are the basic requirements, which we have all fitted into the new Reventon Allround. The relatively slim blank, made from High Resistance carbon, the comfortable and easily washable EVA grip plus the SiC guides make these great rods quite nice and durable, as well as suitable to fish with float, with bombardas, bottom leads and floating feeder, as well as hunting predators with livebait



Code	Length	C. Length	Sections	CW	Guides
151-97-100	3.30	98	6	10-30	S-SiC
151-97-200	3.30	98	6	20-60	S-SiC
151-97-300	3.30	98	6	40-80	S-SiC
151-97-400	3.60	98	6	20-60	S-SiC
151-97-500	3.60	98	6	40-80	S-SiC

## INDULGENCE SPECIMEN

S.H.M.R. CARBON

Telescopic series developed to offer the pleasure angler affordable rods with compact closed length, reliable structure and good performances. In other words, everything needed to catch big size fish, packed in a few centimetres. The butt section length couldn't be shorter than it is, because reel seat position is an important specification for this sort of rods, which are destined to cast heavy feeders or simple ledger bomb with paste bait for carp and barbel fishing, both in lakes and fast running rivers. Blanks are made from High Resistance carbon, whose main difference with High Modulus is the ability to bear extreme stress, coming from fast and furious fights but also from hard life on the banks or on the boat. With their metal frame, guides are really unbreakable, while their SiC ring protects line from abrasion and excessive heating.



Super strong metal frame guides with SiC ring.



Comfortable Rubber handle grip and butt grip. Graphite screw reel seat.



Trabucco logo is finely engraved on aluminium butt cap.

Code	Length	C. Lt	Sect.	Test lbs	Guides
156-30-100	3.60	78	6	3.00	Metal Frame + SiC
156-30-200	3.60	78	6	3.50	Metal Frame + SiC
156-30-300	3.60	78	6	4.00	Metal Frame + SiC

## EXCURSION T-SPECIMEN

CROSSED REINFORCED S.H.M.R. CARBON

In spite of relatively slim blank, it has no problems with big barbel, carp, catfish and eels, thanks to the High Resistance carbon construction which has proven to be extremely strong during preliminary field tests. Most anglers across Europe tend to specialize their fishing on just a single species, or like to go fishing in a limited number of venues. Therefore, they accumulate a lot of experience and skills in a relatively short time, getting good catches and good reputation as well. This new Excursion rod is expressly dedicated to them, with nice but effective specifications like tubular top, quality double leg guides and screw reel seat with steel hoods. The closed length of just one metre allows it to be stored in the car booth: always ready to get into action!



Double leg SiC wrapped guides.

Code	Length	C. Length	Sections	Test lbs	Guides
156-41-360	3.60	99	5	3.00	SiC



## LEGION CARP

S.H.M.R. CARBON



A wonderful telescopic rod, only 106cm when it's closed. The secret lies in the design: seven sections that can provide enormous power both during casting and during retrieving. Like all the telescopic rods, it has been de-

signed for quick sessions. The Legion Carp is a medium-high level rod and its action is very similar to that of a two-pieces construction. Equipped with double leg Sic guides.

Code	Length	C. Length	Sections	Test lbs	Guides
156-24-350	3.60	106	7	3.00lb	SiC



## IMPRESSION

CROSSED REINFORCED S.H.M.R. CARBON



Telescopic rod in High Resistance Carbon reinforced with Carbon Tape spiral wrapping and Carbon Yarn Cross wrapping. Available in 3,60m length with 3,00 Lbs test curve. The Impression

has a very powerful action for distance casting, and it is equipped with Super S-SiC guides. Very manageable and easy to transport when closed.

Code	Length	C. Length	Sections	Test lbs	Guides
156-22-360	3.60	107	7	3.00lb	SiC



## INSOLENCE

S.H.M.R. CARBON



Many anglers prefer telescopic rods because they are obviously very easy to transport and because they can be prepared faster. The NEW INSOLENCE range of rods are very strong and characterized by a progressive action. Made in HR Carbon and kev-

lar yarn wrapping to increase the power. Equipped with SiC guides, anti-slip EVA handle and latest design ergonomic screw reel seat. Ideal for those anglers who are looking a practical rod with great performance.

Code	Length	C. Length	Sections	Test lbs	Guides
156-29-360	3.60	84	7	3.00lb	Metal Frame + SiC
156-29-365	3.60	84	7	3.50lb	Metal Frame + SiC
156-29-390	3.90	84	7	3.50lb	Metal Frame + SiC



# SURFCASTING

Great dedication and countless working hours made the Trabucco brand a landmark in the surf casting universe, not only in Europe but in the whole world, where top anglers of the most prestigious national teams, such as UK and Ireland, decided to use Trabucco rods for the most important competitions. To stop now it will be crazy, because the world is going ahead and the surf casting of nowadays is already light-years far from the surf casting of just 5 years ago. That's why we built a team of experienced competition anglers, to help the brand to switch to the next level and create a new generation of surf casting rods. The results of this co operation is under your eyes and we are really proud of it, because we know that now more than ever before we are ahead of anyone else, on the highest step of the podium.



## POETICA KW TORZITE

**FAST REACTION BLANK**  
**XTRA CASTING PERFORMANCE**

zero  
friction  
drag

**FH  
RIP  
TIP**

**Fuji**

**LRC**  
LOW RESIN  
CONTENT

**CX2**  
CARBON  
NANO-TEK

During the past season, it has been dominating the discussions within elite surf casting clubs, and comments have gone beyond the expectations of those who had the insight and courage to move forward the target for the entire industry. Today everybody knows what the Poetica KW is, they appreciate its total reliability and recognize the merit of having boosted not only the Trabucco image, but also the performance and satisfaction of the best European surfcasters. First of all, the blank is made from super high modulus CX-2 Nano Tek carbon with low resin content, far lighter but better performing than any other carbon. Then we finely tuned a special tip where the bending curve is distributed to have a softer final part, made of glass, and a stiffer lower part made of carbon. The name for this special tip is FH-Rip Tip. Such a tip is really pushing during the cast, but it is quite sensitive when fishing, even with rough sea. Poetica KW is not a rod for everybody, it is a tool for demanding people that need a super rod able to cast as no other one, a true competition rod, competing with other anglers, competing with fish very far from the shore, competing with the strength of the sea. The Poetica KW is

equipped with best guides ever made: the brand new super high tech Fuji Torzite with Titanium K design frame, able to prevent any dangerous line tangle. The Poetica is the first surf casting rod featuring such guides! The inner diameter of the Torzite is 15% bigger than any other guides having same outer diameter, consequently they help casting even more. The reel seat is a Fuji DNPS Gold Label. Top rod ever!

Code	Length	C. Length	Sections	C.W.	Guides
170-99-160	4.25	145	3	160	Fuji TKWTG
170-99-165	4.50	157	3	160	Fuji TKWTG
170-99-200	4.25	145	3	200	Fuji TKWTG
170-99-205	4.50	157	3	200	Fuji TKWTG
170-99-250	4.25	145	3	250	Fuji TKWTG
170-99-255	4.50	157	3	250	Fuji TKWTG

### SPECIFICATIONS



**FUJI GOLD REEL SEAT**  
On the Poetica MN range, we selected only the best components and as reel seat we used the ultra reliable Fuji Dnps gold label, entirely built by graphite it offers a great strength, ergonomic and designed to last longer.



**BUTT CAP**  
The rod's butt ends with a soft rubber handle, which provides the perfect grip to control the rod during most quick and powerful casts. The rounded butt cap is particularly useful to lock the rod to the groin when a big fish is being retrieved.



**FH RIP TIP**  
The Nano Tek high modulus carbon sheet, which gives power to Poetica's blank, sweetly blends into softer materials to provide the right sensitivity to detect fish bites. But the conversion is gradual, within the tubular top section, and this requires high class technology to avoid weak points and curve imperfections, which would cause a bad power transfer. All over the world, this concept is well known as "multi-action tip", but it's not equally common the process of layer's overlapping and fusion which bring to a perfect result, inch by inch.



# POETICA KW TORZITE



The top of the top, the buttonhole of the Trabucco surf casting range cannot have a different name than Poetica, a name that gained reputation at the highest level of the international competitions.



**TITANIUM**  
Ultralight Titanium frame.



Compared to SIC guides of same size, a Torzite guide offers a 15% wider ring, offering more room to running line. In addition, less weight applied to rod's blank (20-30%) means that it has more freedom to fully develop its reactivity, with great advantage on casting distances.



**ULTRA LOW FRICTION**

Torzite's gently round cross section shape allow the ring to contact line in double the length compared to the Sic. Thanks to it, the pressure to the ring is reduced half compared to the Sic.

The load is spread in the POINT

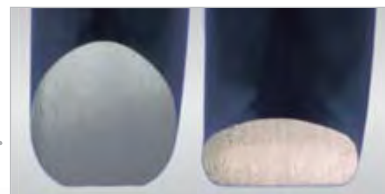
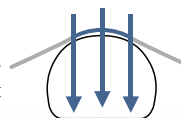

The load is spread in the length of the contact.

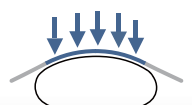

**Tangle Free**

During their endless research and development activity, Fuji engineers found the most advanced ceramic with a very compact structure and extremely smooth surface, being 40% lighter than Silicon Carbide (SIC).

Thanks to a dramatically angled ring, Fuji solved the line tangle problem forever. A common problem which normally causes time loss, sometimes line breakage and, in worst cases, even rod breakage.

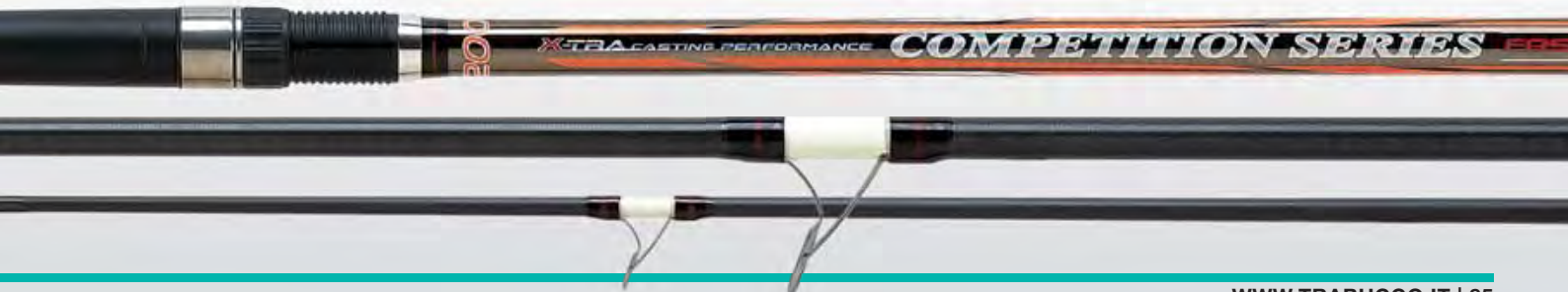
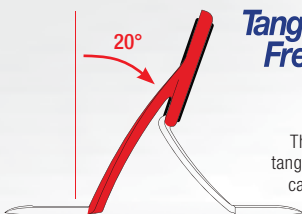

**NEW** CASSIOPEA XTR SURF

A definitely brilliant rod series, which stands off the average for its interesting list of technical specifications. The blank is made from CX-2 Nano LRC, a low resin content carbon of the highest modulus available. The whole range of casting weight models has an impressive fast reactive action and it can be used in whatever sea or wind condition. The components are top level: genuine Fuji Alconite guides with fluorescent inserts and genuine Fuji Gold Series reel seat. The 4.50 meters versions features a more parabolic action to allow any kind of casting style. The Cassiopea 120 gr, unlike other casting weight models, fits 7 guides, the perfect choice to drive the tighter line coils created by smaller sized reels. More powerful models have 8 guides and must be combined with bigger reels (8000 and 1000 sizes). We want to highlight the heavier model too, a 300 g casting weight rod, one of the most powerful surf rods on the market. This model is actually able to accomplish any challenge and it is a perfect choice for shark and rock fishing with live bait. The super sensitive tubular carbon tips mounted on each model have been crafted in order to be active also during the casting action, when they help to push your lead to the horizon.



Code	Lungh.	C. Length	Sect.	C.W.	Guides	
171-52-120	4.20	145	3	120	Fuji A MN	
171-52-125	4.50	157	3	120	Fuji A MN	
171-53-160	4.20	145	3	160	Fuji A MN	NEW
171-53-165	4.50	157	3	160	Fuji A MN	NEW
171-53-200	4.20	145	3	200	Fuji A MN	NEW
171-53-205	4.50	157	3	200	Fuji A MN	NEW
171-53-300	4.20	145	3	300	Fuji A MN	NEW



# IMPERA





The Nano Tek high modulus carbon sheet, which gives power to Poetica's blank, sweetly blends into softer materials to provide the right sensitivity to detect fish bites. But the conversion is gradual, within the tubular top section, and this requires high class technology to avoid weak points and curve imperfections, which would cause a bad power transfer. All over the world, this concept is well known as "multi-action tip", but it's not equally common the process of layer's overlapping and fusion which bring to a perfect result, inch by inch.



As stated in a famous advertising slogan, power is nothing without control. This is true more than ever for surf casting rods, designed to be loaded to their maximum physical possibilities. That's why Trabucco pays great attention to the design of the handle, adding to the butt section of Cassiopea XTR a contoured and rubber dressed grip, which proves vital to the purpose of the rod's control during the delicate phase of the cast.



The guides wrapped on Cassiopea XTR are double leg Fuji MN Alconite. If the quality of the inner ring must be high, because it gets in direct contact with the fishing line, the rigidity and corrosion resistance are important requirements for the steel frame. In all this, Fuji excels worldwide. Between the guide's feet, a phosphorescent painted area helps rod's visibility while night fishing.



## IMPERA

**FAST REACTION BLANK**  
XTRA CASTING PERFORMANCE

Zero Resin  
Carbon Blank

HY  
HYBRID TIP

TITANIUM  
GUIDE

Fuji

LRC  
LOW RESIN  
CONTENT

CX2  
CARBON  
NANO-TEK

The new series of surf casting rod Impera is born for competition, designed with the contribution of the whole Trabucco Surf Casting Team that tested the blanks for months. The final result is an excellent combination of performance, light weight and reliability. The rod has been made using the fantastic super high modulus CX-2 Nano Tek carbon, a special super stiff but super light weight material, due to the extremely low percentage of resin. A so powerful but also a so balanced blank is perfect for long fishing sessions that won't break your back in two. The tip is hybrid, a solid carbon tip that is perfectly connected to the lower hollow part, strong and sensitive. A so technological blank deserves top components such as Titanium frame SIC SeaGuide guides

and Fuji DNPS Gold Label reel seat.

Code	Lungh.	C. Length	Sect.	C.W.	Guides
171-56-160	4.25	145	3	160	Sea Guide Tit. SiC
170-56-165	4.50	157	3	160	Sea Guide Tit. SiC
171-56-200	4.25	145	3	200	Sea Guide Tit. SiC
171-56-205	4.50	157	3	200	Sea Guide Tit. SiC
171-56-250	4.25	145	3	250	Sea Guide Tit. SiC
171-56-255	4.50	157	3	250	Sea Guide Tit. SiC

### SPECIFICATIONS



#### CX-2 NANO-TEK LRC

Last generation Super High Modulus Carbon produced with an exclusive process that allow to produce an extremely pure carbon fibre with a very low resin content. Such a pure material greatly enhances the mechanical response to stress, thus being much higher than the Carbon usually used to build fishing rods, and has a very low specific gravity. The final result given by this technology is a super performing, extremely light fishing rod.



#### SEA GUIDE TITANIUM SIC

The inner stone, made of SiC, is the best you can get in term of smoothness, heat dispersion and abrasion resistance. But the strongest point of the new Titanium guides is undoubtedly the stiffness and the lightness of the frame. Titanium is also salt water resistant, so this material has incredible properties indeed! A rod equipped with Titanium guides will always have superior performance because the action of the blank will not be influenced by the weight of the guides.



#### FUJI GOLD REEL SEAT

On the Impera range, we selected only the best components and as reel seat we used the ultra reliable Fuji DNPS gold label, entirely built by graphite it offers a great strength, ergonomic and designed to last longer.



**BUTT CAP.** Special rubber butt grip with rounded rubber cap, it helps all the operations during the casts or when fishing and additionally it has the function to protect the butt end.



**HYBRID TIP.** In order to give Impera the highest possible sensitivity, a carbon solid tip has been inserted, glued and carefully wrapped on to the tubular portion of top section. This solution required a specific technology to obtain strength around the joint area and curve perfection of the whole top. The most delicate bites

are consequently shown at their best, while at the same time the strike is very accurate and safe, enabling the use of relatively fine hooklinks.



# KRYPTERIA



Hi grade series of powerful yet sensitive surf casting rods, designed in three equal sections with small diameter's blanks. They are built from CX-2 Nano LRC, a special low resin content carbon material. These rods feature a very sensitive solid carbon tip. The Krypteria show peculiar specifications that can be appreciated notably on the 4.50 models, as the moderately fast action make these rods suitable for every casting technique. The light weight and robust blank is reactive and you can feel its casting power in every moment of your casting action. The outstanding components are top quality and salt water resistant: Sea Guide Titanium frame guides with inner SiC ring, Fuji Gold Series ergonomic reel seat and Trabucco rubber butt grip.

Code	Length	C. Length	Sections	C.W.	Guides
171-50-120	4.20	145	3	120	Titanium SiC
171-50-125	4.50	157	3	120	Titanium SiC
171-50-160	4.20	145	3	160	Titanium SiC
171-50-165	4.50	157	3	160	Titanium SiC
171-50-200	4.20	145	3	200	Titanium SiC
171-50-205	4.50	157	3	200	Titanium SiC

## SPECIFICATIONS



### TITANIUM GUIDE

The inner stone, made of SiC, is the best you can get in term of smoothness, heat dispersion and abrasion resistance. But the strongest point of the new Titanium guides is undoubtedly the stiffness and the lightness of the frame. Titanium is also salt water resistant, so this material has incredible properties indeed! A rod equipped with Titanium guides will always have superior performance because the action of the blank will not be influenced by the weight of the guides.



### CX-2 NANO-TEK LRC

Last generation Super High Modulus Carbon produced with an exclusive process that allow to produce an extremely pure carbon fibre with a very low resin content. Such a pure material greatly enhances the mechanical response to stress, thus being much higher than the Carbon usually used to build fishing rods, and has a very low specific gravity. The final result given by this technology is a super performing, extremely light fishing rod.



# NEMESEEA MN



Series of three section's rods based on very well tested blanks, made from CX-1 Micro Pitch Carbon, a strong, reliable and fast reactive material that matches modern market requests. This series features very good salt water resistant finishing and components such as a genuine Fuji Gold Series ergonomic reel seat and Sea Guide Hero Hi-Grade guides with SiC

rings. The Nemeseea MN is offered at an average price but it is the only rod in this segment whose performance can be compared to top level rods. The wonderful cosmetic does justice to the brilliant action.





**FUJI GOLD REEL SEAT**

You cannot avoid to use a Fuji equipment when you want a first quality accessory for your rod. Surf Casting anglers usually mistreat their rods, using them in an aggressive environment and in extremely tough conditions. The Fuji Gold reel seat is the best you can get in terms of longevity and safety, always keeping your reel right into its position without any problem for years and years..



**BUTT CAP**

The Krypteria is an outstanding rod that is light and robust. That's why we decided to equip it with a rubber Butt Cap. The rubber sort we used is extremely tough, standing against abrasions and salt water, but it is also extremely light. To some people it can seem a worthless detail but, on the contrary, it is icing on the cake. And we love to take care of our products, even for the smallest details.



Emiliano Tenerelli

Code	Length	C. Length	Sections	C.W.	Guides
171-21-120	4.20	145	3	120	Sea Guide SiC
171-21-125	4.50	157	3	120	Sea Guide SiC
171-21-160	4.20	145	3	160	Sea Guide SiC
171-21-165	4.50	157	3	160	Sea Guide SiC
171-21-200	4.20	145	3	200	Sea Guide SiC
171-21-205	4.50	157	3	200	Sea Guide SiC



**X-RIDE SURF**

6500  
8000  
10000



WORM SHAFT GEAR  
**WSG**

**POWERBAIL**

**AVS**  
ANTI VIBRO SYSTEM

**STAINLESS STEEL COMPONENTS**

**ONE WAY CLUTCH**

**AS** **ROLLER**  
ANTI TWIST SYSTEM

**SS** **SLOW OSCILLATION SYSTEM**

For special techniques such as light surf and beach ledgering it is common to use light weight rods with limited casting weight. Having said that, it is not true you must give in to fish very far from shore. Main problem is that very few reels have the specs that can combine with these light rods. So you need a wide spool reel and, at the same time, a light weight reel otherwise you will compromise the balance between rod and reel.

Find out more on page 178





## ATHENA X-TREME



The Athena series was born in the end of 2013 and it has been so welcomed by anglers to deserve after a so short time an upgraded version. The new Athena is made of a very special carbon, whose fibers are wrapped really tight to get an extremely reliable and stiff blank. This carbon, the CX-1 Micro Pitch is one of the reasons why this rod will be among the best sellers for 2015 too. Accurately finished and with a nice brilliant yellow

colour, now definitely THE Athena colour, the blank is equipped with SiC corrosion proof SeaGuide guides. The Fuji DPS reel seat is ultra reliable and will not suffer salt and sand. For the Athena we selected an hybrid tip as well.



## EPICA X-CAST



Maybe it is not evident but the Epica series are very likely the best selling series within the Trabucco assortment. This happens because the Epica rods feature the most advanced solutions and technology, normally displayed on top class rods, at very affordable price. The new XCast series is a very good example of wise designing e top components. Available both in the classic

4.20m length and in the longer 4.50m, much appreciated by people engaged in competition. The blank is made of high modulus carbon CX-1 Micro Pitch and it is equipped with first class SiC SeaGuide guides, to reduce the friction with the line. The stainless steel frame is corrosion free. The Webo DPS reel seat is reliable and will last forever. The ergonomic lower part of the handle will help you to get the best from your casting ability. The tip is hybrid, a solid carbon part that is perfectly connected to the lower hollow part, strong and yet sensitive.



## LANCER SURF

- Aluminium Power Bail with Anti Twist roller
- High strength stainless steel main shaft
- Worm shaft system with slow oscillation
- Machine cut aluminium handle
- Sealed drag, with PTFE coated disks



Find out more on page 180

Salvatore Bonaccorso



Fuji DPS graphite screw reel seat.



Double leg SiC guides

Code	Length	C. Length	Sections	C.W.	Guides
171-68-160	4.20	145	3	160	Sea Guide SiC
171-68-165	4.50	157	3	160	Sea Guide SiC
171-68-200	4.20	145	3	200	Sea Guide SiC









Code	Length	C. Length	Sections	C.W.	Guides
171-70-160	4.20	145	3	160	Sea Guide SiC
171-70-165	4.50	157	3	160	Sea Guide SiC
171-70-200	4.20	145	3	200	Sea Guide SiC
171-70-205	4.50	157	3	200	Sea Guide SiC



## TAPER LEADER & VELVET PRO CAST

Spool containing ten tapered shock leaders of 15 meters each, specifically designed for surf casting. Equipped with an exceptional resistance to abrasion, which ensures their prolonged use, they are available in six different combinations of diameters.

Specially developed for Surf Casting competitions, it's produced in an intense, warm yellow colour which is quite visible both under daylight and during the night, when the head lamp allows to immediately find the real direction taken by the line. Extremely soft, velvet skinned thanks to silicone treatment and without memory.



Find out more on page 216

**NEW** **MAGNETICA SURF**

**FAST REACTION BLANK**  
**XTRA CASTING PERFORMANCE**

**FY** HYBRID TIP

**Zero Friction**  
**Webco**

**CX-1**  
**CARBON**

Series developed to offer the good level angler three different casting powers, graphically highlighted by some elegant color inserts, coordinated to guide's wrappings. The blank made from CX-1 High Modulus carbon gives the best in terms of casting distance, while the bite sensitivity is the task of the hybrid tip section, composed of a tubular part and a solid carbon tip, inserted from top, glued and wrapped. The physical control of the rod, during the cast, is eased by the anatomical rubber grip which is placed at the lower end of butt section. The SiC guides have the K shaped frame to prevent the formation of line tangles, with the curved design arms which sweetly drive the more undisciplined

line coils towards the center of the ring. The graphite screw reel seat is Webo quality.

Code	Length	C. Length	Sections	C.W.	Guides
171-81-100	4,20	147	3	200	K Profile SiC
171-81-200	4,20	147	3	225	K Profile SiC
171-81-300	4,20	147	3	250	K Profile SiC



**SERENITY COMPETITION**



A little for the competition and a little for normal anglers; the Serenity Competition is

a rod with very good performance but offered for an affordable price. For sure this rod is one of the more pleasant easy to use on the beach, and this is due to the perfectly balanced blank that can be used for hours with no strain. Casting performance is outstanding due to the building material, the high modulus CX-1



**TAPER LINE**



Monofilament developed for surf-casting, offering exceptional abrasion resistance and great tensile strength. At both ends, the last 15 meters are tapered to act as a shock leader. The absence of knot eliminates the possibility of breaking under tension.

Find out more on page 216

**XPS SURF DISTANCE**



XPS Surf Casting Distance monofilament displays some important features: the light pink colour used allows to easily detect the line, which is extremely important on this kind of fishing. Totally memory free and smooth, this line will make possible to reach extreme casting distance.



**FAST** REACTION BLANK  
XTRA CASTING PERFORMANCE

**HY** HYBRID TIP

**Zero** Friction Blank

**CXO** CARBON MICRO-PITCH

carbon and the smooth SIC SeaGuide guides. The tip is hybrid, a solid carbon part that is perfectly connected to the lower hollow part, strong and yet sensitive.

Code	Length	C. Length	Sections	C.W.	Guides
171-69-160	4.20	145	3	160	K SIC
171-69-165	4.50	157	3	160	K SIC



## MAXXIS HYPER SURF

With a complete saltwater protection and sealed ball bearings, it's well prepared to face the tough life at sea side, its true vocation. But it's not just that: the new series Maxxis Hyper Surf offers a lot more, starting from a perfect volume's ratio which is based on a compact body and large spool, destined to smoothly handle the line with its wide diameter, tapered profile and slim lip. The worm shaft is behind a clean line lay, and the job is done with slower than standard oscillation; the best way to provide a quick, neat and trouble free cast is to regularly wind the line onto the spool, and in this sense Maxxis doesn't fear the comparison to the rest of surf casting reels. The aluminium handle is nicely swept to keep its barycentre as close as possible to body's axis, thus limiting the oscillations during the retrieve. With such list of technical specifications, everybody would expect an high price, but this is surely going to shock the whole beach community.



WORM SHAFT GEAR **WSG**

**SOS** SLOW OSCILLATION SYSTEM

**ONEWAY CLUTCH**

**AVS** ANTI VIBRATION SYSTEM

**AS** ROLLER ANTI TWIST SYSTEM

Find out more on page 181

**NEW** FOLGORE SUN SEEKER

FAST REACTION BLANK XTRA CASTING PERFORMANCE HY HYBRID TIP CX-1 CARBON



Three sections rod with powerful and progressive action, ideal to achieve long casting distance with little effort. The top section is the hybrid type, with solid carbon tip inserted and glued on top of the tubular portion, in order to provide great sensitivity on bite detection and during the fight, during which the movements of the fish are neatly perceived. The CX-1 High Modulus blank is equipped with double leg MN SiC guides,

resistant to saltwater aggression. At the base of the handle, a segment of rubber grip eases the operation's control during the casting action.

Code	Length	C. Length	Sections	C.W.	Guides
171-82-100	4.20	145	3	200	MN SiC

**NEW** FOLGORE DREAM CAST

FAST REACTION BLANK XTRA CASTING PERFORMANCE HY HYBRID TIP CX-1 CARBON

Rod made of three sections, which displays a fast and powerful action, able to easily cast up to 200 grams effective. Despite the great power given off, the fishing and playing sensitivity is granted by the fantastic hybrid top section, which starts from a tubular structure and ends with a solid carbon tip. For its construction we used the reliable High Modulus carbon CX-1 and applied low profile SiC guides, a typically British solution that boosts even more the casting distance, in addition to allowing the

use of the multiplier reel. Components are 100% saltwater resistant.

Code	Length	C. Length	Sections	C.W.	Guides
171-82-200	4.20	145	3	200	Low Profile SiC



IRIDIUM PROGRESS

FAST REACTION BLANK HY HYBRID TIP Zero Friction Blank CX-1 CARBON



Three sections surf casting rod representing a very good compromise between cost and performance. The high modulus carbon blank is covered by the Zero Friction Blank varnish and it is made for the long distance. Really handy, its action is pretty fast and

accurate during the casting phase. The ergonomic handle on the lower part of the butt section is a great help for casting. The tip is hybrid, a solid carbon part that is perfectly connected to the lower hollow part, strong and yet sensitive.

Code	Length	C. Length	Sections	C.W.	Guides
171-72-200	4.20	145	3	200	MN SiC





## IRIDIUM DISTANCE



Three sections surf casting rod representing a very good compromise between cost and performance. The high modulus carbon blank is covered by the Zero Friction Blank varnish and it is made for the long distance. Really handy, its action is pretty fast and accurate during the casting phase. The ergonomic handle on the lower part of the butt section is a great help

for casting. The low profile SIC guides are very popular in Spain and they give some extra meters to your casts. The tip is hybrid, a solid carbon part that is perfectly connected to the lower hollow part, strong and yet sensitive.



Code	Length	C. Length	Sections	C.W.	Guides
171-71-200	4.20	145	3	200	Low Profile SIC



## SUSPIRIA HYPERCAST



The Suspiria is made of high resistance carbon reinforced by a special design of carbon fibers intended to make it more reactive and fast. The 200g casting power is real, making this rod a good choice for people searching for a long distance device. The Suspiria can face heavy sea with no problem and still be enough sensitive to detect bites, thanks to the hybrid solid carbon tip. Equipped with SiC MN guides with stainless steel frame.

Code	Length	C. Length	Sections	C.W.	Guides
171-73-160	4.20	145	3	200	MN SiC

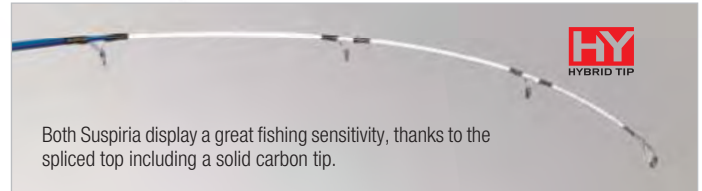

Both Suspiria display a great fishing sensitivity, thanks to the spliced top including a solid carbon tip.

## NEW SUSPIRIA ORIZZONTE



Rod built from High Resistance carbon and reinforced in the joints area by a particularly effective weaving of carbon fibers, which enhances responsiveness to load. The casting weight of 200 grams is absolutely real and makes Suspiria Orizzonte the right choice for the long casting and fishing in rough seas conditions. The rod provides exceptional qualities of sensitivity, thanks to hybrid top section including solid carbon tip. It fits Low Profile SiC guides, with a corrosion proof frame. According to the results of field tests,

this special type of guides ensures longer casts and less risk of breakage. It is the standard for some countries such as Spain and the United Kingdom.

Code	Length	C. Length	Sections	C.W.	Guides
171-74-300	4.20	145	3	200	Low Profile SiC



## SURF TACKLE

With the inclusion of some new items, the range of small specialist accessories Trabucco Pro Surf grows again. For 2016 the series of stainless steel Powerclip is going to be a winner, as they are equipped with heat-shrink tube already shaped for a perfect fit. Brilliant are the Mini Trave, fitted with quality swivels and beads, designed to simplify the connection of hooklinks and leads, encouraging their quick exchange. With the confirmation of the Mini Beads, Cones and rubber Stoppers, today we can talk about a "Trabucco system" for advanced surfcastmen.

**MINI-TRAVE**  
**DISTANCE**  
**COMPETITION**  
**SS POWERCLIP**

Find out more on page 343





**NEW** SUSPIRIA INFINITE SURF



It's one of the most powerful three-sections surf rods in the Trabucco range. The blank is made from High Resistance carbon, and is perfectly connected to the hybrid top section, which includes a sensitive solid carbon tip, intended to highlight the fish bites. But so much power requires a comprehensive control, which is ensured by the handle grip at the base of butt section, ergonomically shaped and dressed with soft rubber. The guide's configuration is traditional, with double-leg SiC guides, whose frame is resistant

to saltwater aggression. The robust graphite screw reel seat with steel hoods completes the absolutely reliable assembly.

Code	Length	C. Length	Sections	C.W.	Guides
171-74-400	4.20	145	3	225	K Profile SiC



SURF CASTING HOOK

Along with baits, hooks are the most important components of the whole fishing system. The key factor is bait's presentation. Once in the water, the hookbait must move naturally, and its volume must drive the hook's pattern and size choice.



Find out more on page 244



## FOSTORIA COASTMASTER

XTRA FAST REACTION BLANK HYBRID TIP Zero Friction Blank CROSSED REINFORCED CX-1 CARBON



New version of the proven Fostoria series. The blank is now more reactive, thanks to the new higher modulus carbon fibres we used. Thanks to this material, the rod is now more balanced too. The Fostoria Coast Master is also much more sensitive thanks to the

new hybrid tip, really useful to spot the more delicate bites and to understand the sea bottom morphology, using the lead as a probe. Equipped with salt water resistant MN SiC guides.

Code	Length	C. Length	Sections	C.W.	Guides
171-45-420	4.20	145	3	200	SiC MN

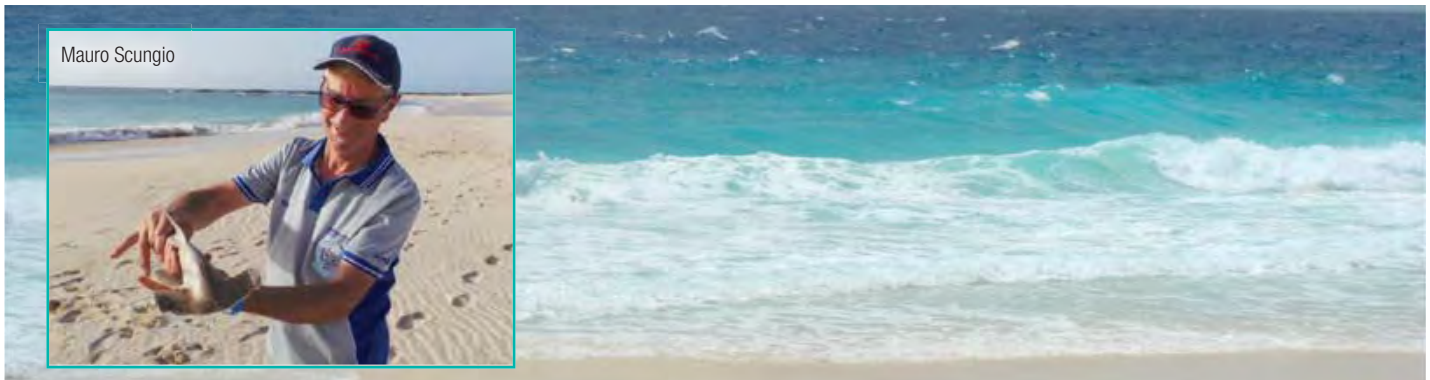

Mauro Scungio

## XTR SURFCASTING PRO TEAM

Nowadays, surf casting is an advanced sea fishing branch, which in Italy has seen a fast development, more than in the rest of Europe; along with thousands of pleasure anglers there are many match surf fans, who like to adopt the finest quality tackle and accessories. To them, Trabucco offers a new range of technical luggage, showing a young and intriguing design, based on black and chartreuse, a trendy colour in between yellow and green, which moved from the fashion world to pervade other fields of the industry. But cosmetic is just one of the interesting points of XTR Pro Team range, because materials and practical solutions are destined to impress the end user surely more than it. Using a waterproof and washable material weighing 1200 denier, bags, rucksacks and rod holdalls are built to last. The addition of plastic boxes with many compartments enables to take full advantage of the inside room to neatly store all accessories. The special paddings, the stiff bottoms, the handles and shoulder belts, the zippers and seams are made with great care and precision. Following the wonderful success, today the XTR luggage range expands with some new products and with an interesting family of waterproof containers made from EVA. In particular, the two multipurpose bags stand out for their with zippered lid and reclining handles. With his 6 meters rope and the ability to automatically collapse, the bucket is valuable to pick up water when fishing from elevated places.



# FOSTORIA OVERCAST



Totally new blank for a very well known and appreciated worldwide surf casting rod. The new Fostoria Overcast is made from High Resistance Carbon, a material that grants superior performances both when casting and fishing, thanks to the hybrid carbon/fibreglass

tip. It is evident that every component of this rod is resistant to salt water corrosion, including the low profile SiC guides.

Code	Length	C. Length	Sections	C.W.	Guides
171-46-420	4.20	145	3	200	SiC Low Profile

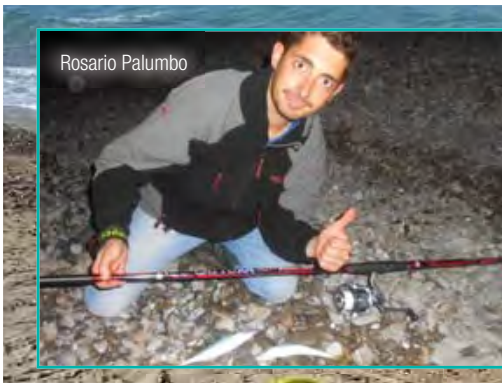

Rosario Palumbo



# XTR

## SURFCASTING PRO TEAM

Find out more on page 332



## ADMIRAL STORM RIDER

Three sections surf casting rod made of carbon whose fibers has been interlaced with a specific design that increases stiffness and consequential casting distance. Despite the very affordable price, this rod can deliver very good performance and the casting power of 160 g is absolutely real. Very good rod for those who start to use 3

## **NEW** ADMIRAL SEA MASTER

Powerful rod, particularly suited for casting, but not displaying an extremely stiff action, in order to allow achieving very long distances even to anglers who aren't particularly expert. The blank is not so fast, but certainly very accurate, thanks to its High Resistance carbon structure. The SiC guides have low profile frame, to keep the friction at minimum level and



## **NEW** ADMIRAL LONG RANGE

It is the most powerful of the Admiral rods, with a High Resistance carbon structure that is not afraid to be loaded to full capacity. In experienced hands, the casting action can be very fast, which is why the rod has been fitted with K shaped frame SiC guides, whose main merit is to prevent the formation of line tangles, a serious danger because it can often lead to rod's breakage. The top section is fully tubular to resist the push by the waves, which in great distance fishing can disturb the bite

detection. The rubber-coated handle grip is much helpful for the control of the rod during the propulsion phase.



Code	Length	C. Length	Sections	C.W.	Guides
171-75-250	4.20	145	3	250	K Profile S-SiC



## **NEW** OCEANIC SURF CASTER

Since long time, Oceanic is the name that identifies the Trabucco series designed for those who approach the world of surf casting with the intention to try three sections rods. Despite the low price, these rods have been designed with the same care and according to the same mentality of rods belonging to upper class. The blank made of High Resistance carbon is exceptionally reliable and is reinforced at the joint's area by a crossed carbon sheet, which also improves the action's fastness. The guides have

a stainless steel frame and SiC ring, to allow the comfortable use of relatively thin diameters of line.



Code	Length	C. Length	Sections	C.W.	Guides
170-54-700	4.20	145	3	250	N S-SiC
170-54-750	4.50	157	3	250	N S-SiC



FAST REACTION BLANK

HY HYBRID TIP

Zero Friction Blank

CROSSED REINFORCED

section surf rods. Also featuring Zero Friction Blank, corrosion free SiC guides and hybrid solid carbon tip.

Code	Length	C. Length	Sections	C.W.	Guides
171-75-160	4.20	145	3	160	S-SiC

FAST REACTION BLANK

HY HYBRID TIP

Zero Friction Blank

CROSSED REINFORCED

resist abrasion caused by braided lines, as they tend to bring sand within their braids. The screw reel seat is able to accommodate large size reels. The top section's construction is hybrid carbon type, to provide good sensitivity and facilitate the bite detection even in presence of rather strong waves.

Code	Length	C. Length	Sections	C.W.	Guides
171-75-200	4.20	145	3	200	Low Profile S-SiC



# CASSIOPEA MX2

The Cassiopea MX2 is the natural evolution of the classic and historical English rods, from whom it takes the basic concepts and contents, changing them according to the most modern needs and the latest technological materials.

## CASSIOPEA MX2



Even if the market in this moment is asking for a large quantity of 3 sections surf rods, for sure the most beautiful rods for surf casting are the 2 sections one, the so called bass rods. The Cassiopea MX2 is the natural evolution of the classic and historical English rods, from whom it takes the basic concepts and contents, changing them according to the most modern needs and the latest technological materials. The blank is incredibly stiff and high performing, made from high modulus CX-2 Nano Tek LRC carbon. The fast action is absolutely fantastic and you will experience the most incredible casting sensation.

The tip section, a key part to define the action of a 2 section rod, is FH Rip Tip, that means that the building involves glass and carbon fibers mixing in a progressive way from the top to the base of the tip. Casting power, accuracy of the cast and finally sensitivity, all is depending on this special tip. The Cassiopea MX2 is equipped with the finest components such as a Fuji DPS Gold Label reel seat and Fuji Alconite guides. The lower handle on the butt section is made by a shrinking tube and a hard rubber butt knob, a perfect solution to secure the hand during the casting phase. Put in joint.

Code	Length	C. Length	Sections	C.W.	Guides
171-54-160	4.15	210	2	(2-6 oz) 160 g	Fuji MNA
171-54-200	4.15	210	2	(3-7 oz) 200 g	Fuji MNA
171-54-230	4.15	210	2	(4-8 oz) 230 g	Fuji MNA



# AERAS HYPERTEK

Very interesting 2 sections surf rod, versatile and performing long distance casting.

## AERAS HYPERTEK



Very interesting 2 sections surf rod, versatile and performing long distance casting. The Aeras is made of the equal sections joint with a spigot and made of high modulus carbon CX-1 Micro Pitch. The building structure of the blank gives the angler sensation he cannot feel without a 2 sections rod. The special FH Rip Tip, made of a combination of glass and carbon, has the typical bend of an English bass rod. Equipped with SiC Seaguide guides with stainless steel frame. The reel seat is Fuji DNPS Gold Label and can easily harbor big pit reels.

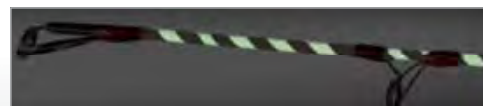

Great visibility during the night, thanks to the glow-in-the-dark tape which wounds the tip.

Code	Length	C. Length	Sections	C.W.	Guides
160-70-100	3.95	200	2	150	Sea Guide Inox SiC
160-70-200	4.15	210	2	150	Sea Guide Inox SiC





SPECIFICATIONS CASSIOPEA MX2 AND AERAS HYPERTEK:



**FUJI DNPS REEL SEAT**

On the Cassiopea MX2 range, we selected only the best components and as reel seat we used the ultra reliable Fuji DNPS gold label, entirely built by graphite it offers a great strength, ergonomic and designed to last longer.



**BUTT CAP**

The butt end cap is a feature that many don't consider. But in fact it helps all the operations during the casts or when fishing and additionally it has the function to protect the butt end. We've designed also special rubber caps also for the inner sections to prevent any damage during the transport.



**FH RIP TIP**

Both Cassiopea and Aeras series feature the fantastic FH Rip Tip top section. It has a tubular structure, and it's built through a special technology. In the top area, which is destined to detect fish bites, the high modulus carbon is gradually replaced by lower modulus materials, up to become 100% fiberglass to get the required sensitivity.

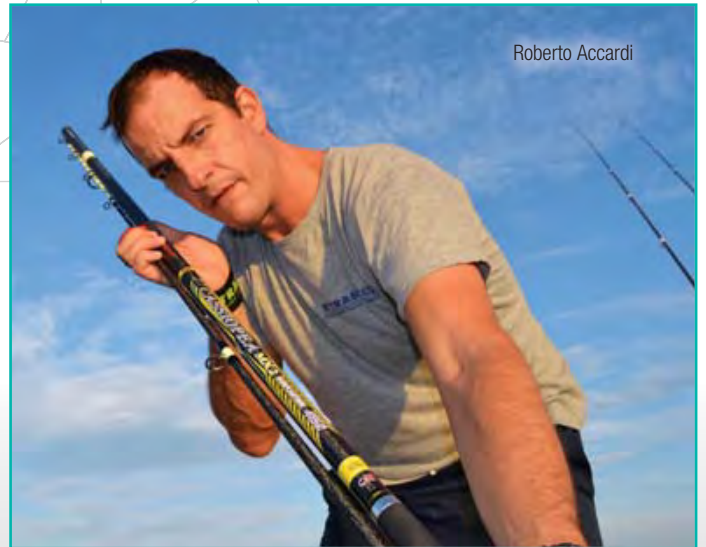

Roberto Accardi

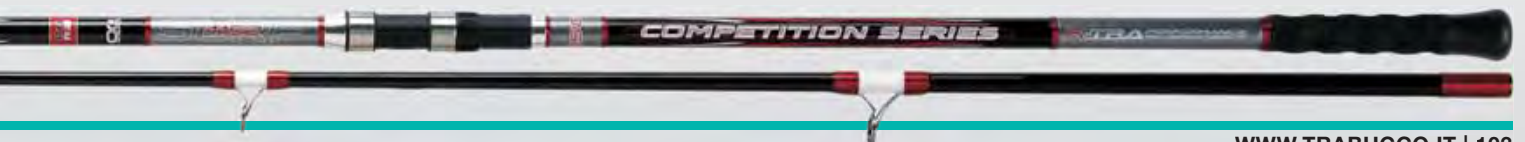

## SURFCASTING TELESCOPIC

*Love and hate. Telescopic surf casting rods don't know half measures. Many anglers just dislike them, but on the other hand, many other will never go fishing without them. We want everybody happy and thanks to our great knowledge and experience that lead us to build the most beautiful 3 sections rods in the world, we think to be able to deliver the best telescopic rods ever. We are so confident in our job that we think that some 3 section's loverS will integrate his own rod range with some of our telescopic! Also for telescopic we invested money, time and attention, we casted thousands and thousands of times, to make our tele-rods the best you can buy.*





## CASSANDRA MN



**FAST REACTION BLANK**  
XTRA CASTING PERFORMANCE



It was difficult to do better than the previous Cassandra, very likely the thinner telescopic surf rod in its class on the market. We think we have succeeded, thanks to the use of the fantastic CX-2 Nano Carbon, a material whose molecules are very tightly linked, allowing you to have less resin in the blank and a more fast response during the cast. The tip is short, without any sliding guide, high performance during the casting action but also sensitive during the fishing action. The butt section is completed with a nice

aluminium and rubber cap. The salt water resistant equipment includes double legs MN Seaguide guides, non-slip grip and screw reel seat.



Built in CX-2 Nano Carbon.

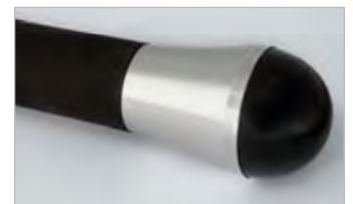

Aluminium and rubber butt cap.

Code	Length	C. Length	Sections	C.W.	Guides
170-88-100	4.20	157	7	100	Sea Guide SiC
170-88-130	4.20	157	7	130	Sea Guide SiC
170-88-150	4.20	157	7	150	Sea Guide SiC

## LOCUSTA XT

It's the natural evolution of former Locusta, of which it keeps the reactivity that had achieved the approval from thousands of Italian surfcaster, making them say that it was casting like a three section rod! Thanks to Emiliano Tenerelli and Trabucco team work, now the action range is wider, offering different casting weights to satisfy current demand. Technical features also grow, as now guides are from Sea Guide to improve resistance to saltwater and reel seat is the same ergonomic model which until yesterday was available on Cassandra series only. Good news also on the butt grip front, which has been shaped to provide total control when the rod is pushed forward and the energy

must be concentrated to reach the targeted distance. Finally, an already high grade series which steps up, strengthening the Trabucco image in the most dynamic segment of sea fishing.

Code	Length	C. Length	Sections	C.W.	Guides
171-58-120	4.20	165	6	120	Sea Guide SiC
171-58-125	4.50	165	6	120	Sea Guide SiC
171-58-150	4.20	165	6	150	Sea Guide SiC
171-58-155	4.50	165	6	150	Sea Guide SiC
171-58-200	4.20	165	6	200	Sea Guide SiC
171-58-205	4.50	165	6	200	Sea Guide SiC

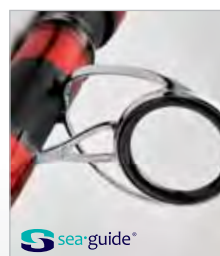

Stainless steel frame Sea Guide SiC guides.



Graphite screw reel seat with stainless steel moving hood. Rubber ergonomic butt grip.







Giuseppe Alesi

**NEW SEATALISMAN XTREME SURF**



It's an high level rod, which provides great sensitivity and total protection for the line with the SiC quality guides made by Sea Guide, an advanced company in the production of components for the sea fishing rods, which are totally free from corrosion risk. The Zero Friction finish of the intermediate sections eases the line's flow in wet conditions, because it prevents it from sticking to the outer wall. The solid carbon tip highlights properly the shiest bites, while the rest of the body, made from CX1 High Modulus carbon, bears brilliantly the casting load and fish reactions.

Code	Length	C. Length	Sections	C.W.	Guides
171-84-100	4.20	156	6	180	SeaGuide SiC
171-84-200	4.20	156	6	200	SeaGuide SiC
171-84-300	4.20	156	6	220	SeaGuide SiC



**NEW NIGHTWISH REVOLUTION**



Nice, very nice, really eye-catching in its young and colourful dress. In the shop, it draws the attention; on the beach, it shows the business card of CX1 High Modulus carbon with an impressive, strong, clean and precise casting action, almost worthy of a rod made in three sections. The relatively high setting of

the ergonomic graphite reel seat, in combination with the contoured rubber grip at the base of the handle, let's immediately understand that it is a race horse in the aspect of the blank's reactivity, to be tamed with a firm and sure handling to get the very best from distance's point of view.



**NIGHTWISH EXTREME CAST**

New series oriented to surfcasting competitions, which takes the DNA from former Nightwish, with addition of some important innovations which give it a new identity. The High Modulus CX-1 carbon has been confirmed for the blank, because it gives the rod the correct reaction to best caster's casting requirements, while the guide's configuration is totally revised. Taking advantage from the excellent quality of Sea Guide frames, the technicians of Trabucco team tested some prototypes with larger diameter's guides, obtaining a better line's flow and consequently longer casting distances. In order to provide the best possible control of the casting operation, they even added the same anatomic butt grip of new Locusta. Brilliant!



Stainless steel frame double leg Sea Guide SiC guides

Special shaped butt grip with rounded rubber cap

Code	Length	C. Length	Sections	C.W.	Guides
171-60-130	4.20	165	5	130	Sea Guide SiC
171-60-160	4.20	165	5	160	Sea Guide SiC
171-60-200	4.20	165	5	200	Sea Guide SiC

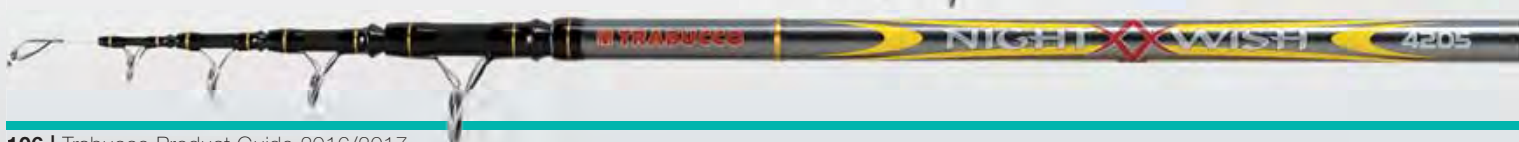

# SEATALISMAN CASTMASTER



Within the vast collection of Trabucco telesurf rods, Sea Talisman is the link between the famous top of the range rods and those destined to the pleasure angler. In fact, this series features some quality specifications, like blank's slimness and responsiveness, but is offered at surprising prices. Therefore, the anglers who like to face their first competitions have good chances without spending a fortune, also finding brilliant reels in the Trabucco line-up to perfectly match these rods. Well refined in the small details, Sea Talisman rods fit MN guides with a special corrosion proof finish, plus the ergonomic graphite reel seat: everything right to bear saltwater injuries and to last long time.

Code	Length	C. Length	Sections	C.W.	Guides
171-59-150	4.20	153	6	150	MN SiC
171-59-180	4.20	153	6	180	MN SiC
171-59-200	4.20	153	6	200	MN SiC



Code	Length	C. Length	Sections	C.W.	Guides
171-83-100	4.20	160	5	150	SeaGuide SiC
171-83-200	4.20	160	5	180	SeaGuide SiC
171-83-300	4.20	160	5	200	SeaGuide SiC



Graphite screw reel seat with stainless steel moving hood. 5 sections telescopic blanks made from High Modulus carbon CX-1.



Rosario Palumbo

## SEA RIG TACKLE

Accessories line for salt water rig preparation, both for boat or surf/beach fishing. Each and every item has been designed to increase your fishing experience and to get maximum results from your rigs.



Find out more on page 344



# ANDROMEDA

## ANDROMEDA TEKNO SURF



*Andromeda family is a classic example of Trabucco's vocation to follow all traditions, trends and even the slightest variations within each single fishing style. A solid tip version, another with tubular top, a third one with special guide's configuration. Different solutions and performances according to the actual conditions of use on the beaches of Mediterranean and not only.*



Surf Casting series fully made of High Resistance Carbon reinforced with Carbon tape in all the point that are subjected to higher stress. These rods are specifically designed to get a strong tip action. The short tip section is solid, strong and sensitive at the same time. This solution allows also more accurate casting. The SiC guides can be used with braided lines. Screw reel seat and non slip handle.

Code	Length	C. Length	Sections	C.W.	Guides
171-25-130	4.20	142	6	130	SiC
171-25-150	4.20	142	6	150	SiC
171-25-180	4.20	142	6	180	SiC



**NEW** ADMIRAL SEAQUEST



A multiform and multifunctional series; practically four series in one, if you see it from the point of view of the application field, ranging from 150 to 220 grams for the coverage of most fishing conditions, typical of surf casting. The dressing includes a stylish touch of colour to identify each action: yellow (150 g), green (180 g), blue (200 g) and red (220 g). In common, the High Resistance carbon used for six sections blank's structure to shorten the rod's closed length, the solid carbon tip, the perfect wrapping with SiC guides and o-ring protection, the anatomic, light yet strong graphite reel seat.

Code	Length	C. Length	Sections	C.W.	Guides
171-85-100	4.20	142	6	150	SiC
171-85-200	4.20	142	6	180	SiC
171-85-300	4.20	142	6	200	SiC
171-85-400	4.20	142	6	220	SiC



ANDROMEDA  
TEKNO CAST



Surf Casting series fully made from High Resistance carbon with tubular carbon tip to enhance the casting power. The 5 sections blank has a slim diameter in the butt section and it allows an easy casting also to surf casting beginners. More expert anglers will not miss to achieve really long distances with these rods. The blanks are reinforced in all areas subjected to extreme stress during casting. SiC guides.

Code	Length	C. Length	Sections	C.W.	Guides
171-26-130	4.20	142	5	130	SiC
171-26-150	4.20	142	5	150	SiC
171-26-200	4.20	142	5	200	SiC

**NEW** DEYLAN  
MASTER SURF



Rod able to display a good casting power, without straining the user and without sacrificing the sensitivity, which is excellently provided by the solid carbon tip. The performance class - up to 150 grams - makes it belonging to the medium gear to fish from the beach, but also from piers and rocky shores, where the Gilt-head Bream and Sea Bream are making most of the dreams and direct experiences of thousands of anglers.

Safety and durability are the credentials of the SiC guides and screw reel seat with stainless steel hoods.

Code	Length	C. Length	Sections	C.W.	Guides
169-23-400	4.00	128	5	150	SiC



## SEARIDER MASTER BEACH



Sensitive rods designed for salt water light fishing, both from the shore and from piers and breakwaters. It can be used from the shore fishing for striped breams when the sea is calm, being able to good distance casting without spoiling the more delicate baits. It can be used from piers and breakwaters using feeders with maggots for all the marine fish that love it. The action of the blank allows the use of low diameter hook length.

Code	Length	C. Length	Sections	C.W.	Guides
169-19-360	3.60	121	5	150	S-SiC
169-19-390	3.90	134	5	150	S-SiC



## NEW AVALON SURFCASTING



Rod series created to propose tools entirely built from carbon fiber, able to offer good performance, to those who approach this discipline for the first time. The series consists of two models of 4 meters, which have respectively 130 and 150 grams of casting power, making them ideal to virtually cover all the basic situations of Surf Casting. The telescopic structure makes it easy to carry and allows even beginners to easily cast at

interesting distances. The brilliant colour coordination with Avalon Surfcast 6500 reels, available with red and blue details, enables to create customized kits.

Code	Length	C. Length	Sections	C.W.	Guides
170-53-300	4.00	134	5	130	S-SiC
170-53-350	4.00	134	5	150	S-SiC

## AVALON GALAXY SURF



Good telescopic rods which take life from a nicely balanced mix of carbon and fibreglass to serve pleasure anglers fishing from the beach as well as from the rocks, where the reliability sits on top of their wish list. The pure carbon is employed on joint's cross reinforcements and to create the white painted solid tip, because the positive end of any fishing session depends mostly from the "communication" between fish and angler. The strong double leg guides, wrapped carefully, feature the vital SiC ring to resist from abrasion caused by salt and sand brought in by the line. Those elements are the worst enemy of any guide, and Trabucco team know it well!



Double leg guides with SiC ring.



Graphite screw reel seat with metal hoods.

Code	Length	C. Length	Sections	C.W.	Guides
170-41-100	4.00	146	5	150	S-SiC
170-41-200	4.20	146	5	150	S-SiC



## SEARIDER PRO SENSOR



## NEW OCEANIC POWER SURF



Among the materials available in the industry, High Resistance carbon is one of the most simple ones, but is worldwide used for its properties to bear high stress and for doing it on the basis of long time term. That's why Trabucco technicians trusted it when designed these Sea Rider, as they liked to offer to newcomers or occasional surfers rods which should have been safe also in front of some inevitable misuse. The top section is made from solid carbon to grant sensitivity and strength, while double leg guides have SiC ring. Reel seat comes from Trabucco's top of the range, with upper hood which is integrated in the shape and lower one screw driven for total safety.

Series of rods featuring an extremely strong blank, made from carbon composite, reinforced in the areas subjected to greater stress. The proposed casting power, 150 and 200 grams, make the rods also suitable for rough seas and fishing from the cliffs with the living bait; the top section is tubular, painted in white on the top end. All guides have double leg frame, with SiC ring to allow the use of braided lines, while sliding ones are wrapped on to carbon pipes. The screw reel seat adds strength and safety. Oceanic Pro Surf 8000 reel is their ideal partner.

Code	Length	C. Length	Sections	C.W.	Guides
169-20-400	4.00	146	5	150	S-SiC
169-20-420	4.20	146	5	150	S-SiC

Code	Length	C. Length	Sections	C.W.	Guides
170-54-500	4.00	137	4	150	SiC
170-54-550	4.00	137	4	200	SiC



## AVALON SURFCAST 6500



The Avalon Surf is offered to an affordable price and designed for those who want to take their first steps in the surf techniques. It shows an elegant cosmetics with an ultra reliable mechanics.

Extremely lightweight despite the size, Avalon Surf features a graphite body and spool, the AS line roller, super balance system and the power handle ends with a soft ergonomic knob. Available in two colors (Red and Blue) for an elegant combination with Avalon rods.



SPOOLED WITH  
**MAX PLUS**

Find out more on page 189



# LIGHT SURF & BEACH LEGERING

*Light Surf and Beach Legering are typically Italian fishing styles, born to adapt the original surf casting to the conditions of the Mediterranean sea, where tides are minimal and waves not as powerful as in the ocean. Both funny and highly specialized, they enable to catch big fish, so that reliable tackle is absolutely a must. Nowadays, Trabucco offers to the wide public of fans a complete range of rods, which have been developed and refined in close cooperation with a team of experts. Blanks which can accurately cast at great distance even the lightest lead, with the sensitivity to detect the most shy bites. Actions which are perfect to employ light lines and sophisticated rigs, engineered to maximise the pleasure coming from the direct contact with the fish.*



Emiliano Tenerelli



## CATTURA MN2 BEACH



The Cattura is so famous among the Beach Legering rods that it does not need any presentation. The Cattura MN2 series is now larger, with the brand new 4.50 m 120 g casting weight model. We received so many requests for a model that could be able to cast farther and still be super sensitive that we decided to design it. The new 4.50m 120 g is the perfect solution for super sensitive fishing at very long distance. We remind you the whole Cattura M2 series feature CX-2 Nano LRC carbon blanks, a material that is almost free of resins and so it becomes more reactive and lighter. All the rods are equipped by 3 solid ultra sensitive carbon put in tips, able to detect bites and to "read" the bottom roughness like a sonar! The first class components include original Fuji Alconite guides and Fuji Gold reel seats.

Code	Size	C.Length	Sections	C.W.	Guide
170-96-420	4.25	144	3+3	100	Fuji A MN
170-96-450	4.50	155	3+3	100	Fuji A MN
170-96-455	4.50	155	3+3	120	Fuji A MN
170-96-500	5.00	170	3+3	120	Fuji A MN



# CASSIOPEA XTR BEACH NEW

Sensitive and highly responsive at the same time, it's a rod designed for competition beach legering. The Cassiopea XTR Beach features an ultra-light slim blank, made from CX2 high modulus carbon with low resin content that enables to succeed in the speed fishing with rod in hand, to perfectly manage a range of weights ranging from 50 to 120 grams. Perfect for surface fishing with floating rigs and extra long arms in calm sea conditions, it offers two interchangeable carbon quiver tips, allowing you to adjust the sensitivity of the rod to the expected size of fish or to the force of the sea. The first (Stiff), is ideal for shock leader fishing, while the second (Soft), is longer and destined to be used with the straight nylon line. Both feature a night glow finish for better visibility in the dark hours. The double leg Fuji MN Alconite guides have a phosphorescent segment between feet's wrappings, while wrapped Fuji NS plate reel seat is corrosion resistant. Quite appealing new design rubber butt grip.

Code	Size	C.Length	Sections	C.W.	Guide
171-55-120	5.00	170	3+2	120	Fuji MN A
171-55-120-R01H			Stiff Interchangeable Tip		
171-55-120-R01L			Soft Interchangeable Tip		

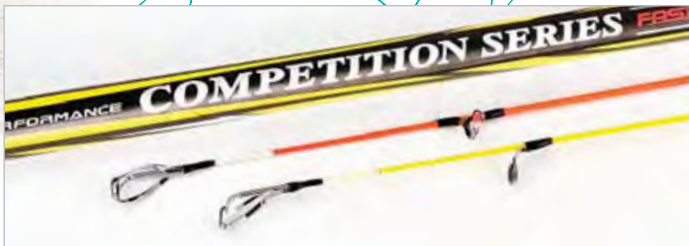

## FEATURES



### FUJI ALCONITE GUIDES

The guide assembly made by Fuji Alconite is the very best on the market! The stainless steel frame supported by Alconite stone (hard and perfectly smooth) provides the best slip of the line.



### FUJI GOLD REEL SEAT

You cannot avoid to use a Fuji equipment when you want a first quality accessory for your rod. Surf Casting anglers usually mistreat their rods, using them in an aggressive environment and in extremely tough conditions. The Fuji Gold reel seat is the best you can get in terms of longevity and safety, always keeping your reel right into its position without any problem for years and years.



### BUTT CAP

The Sirenia is an outstanding rod that is light and robust. That's why we decided to equip it with a rubber Butt Cap. The rubber sort we used is extremely tough, standing against abrasions and salt water, but it is also extremely light. To some people it can seem a worthless detail but, on the contrary, it is icing on the cake. And we love to take care of our products, even in the smallest details.



### SOLID TIPS

Solid Tips Three tips are supplied with the rod:  
 Green: Super sensitive for pier fishing.  
 Yellow: Super calibrated for fishing without shock leader.  
 Red: Tougher action for shock leaders use.

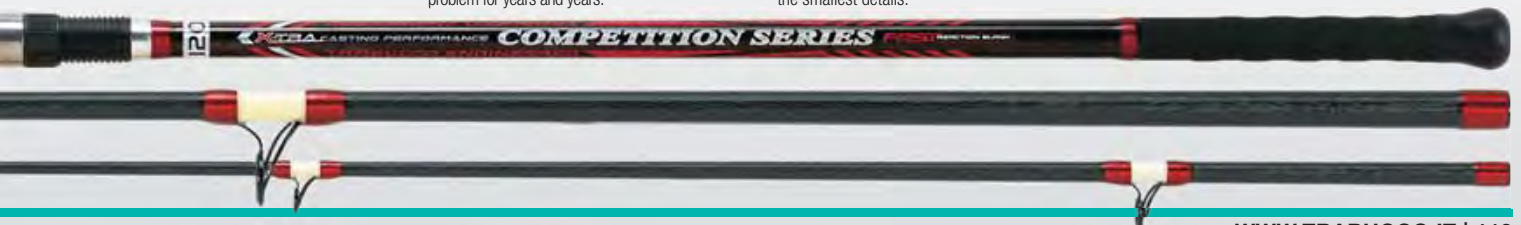



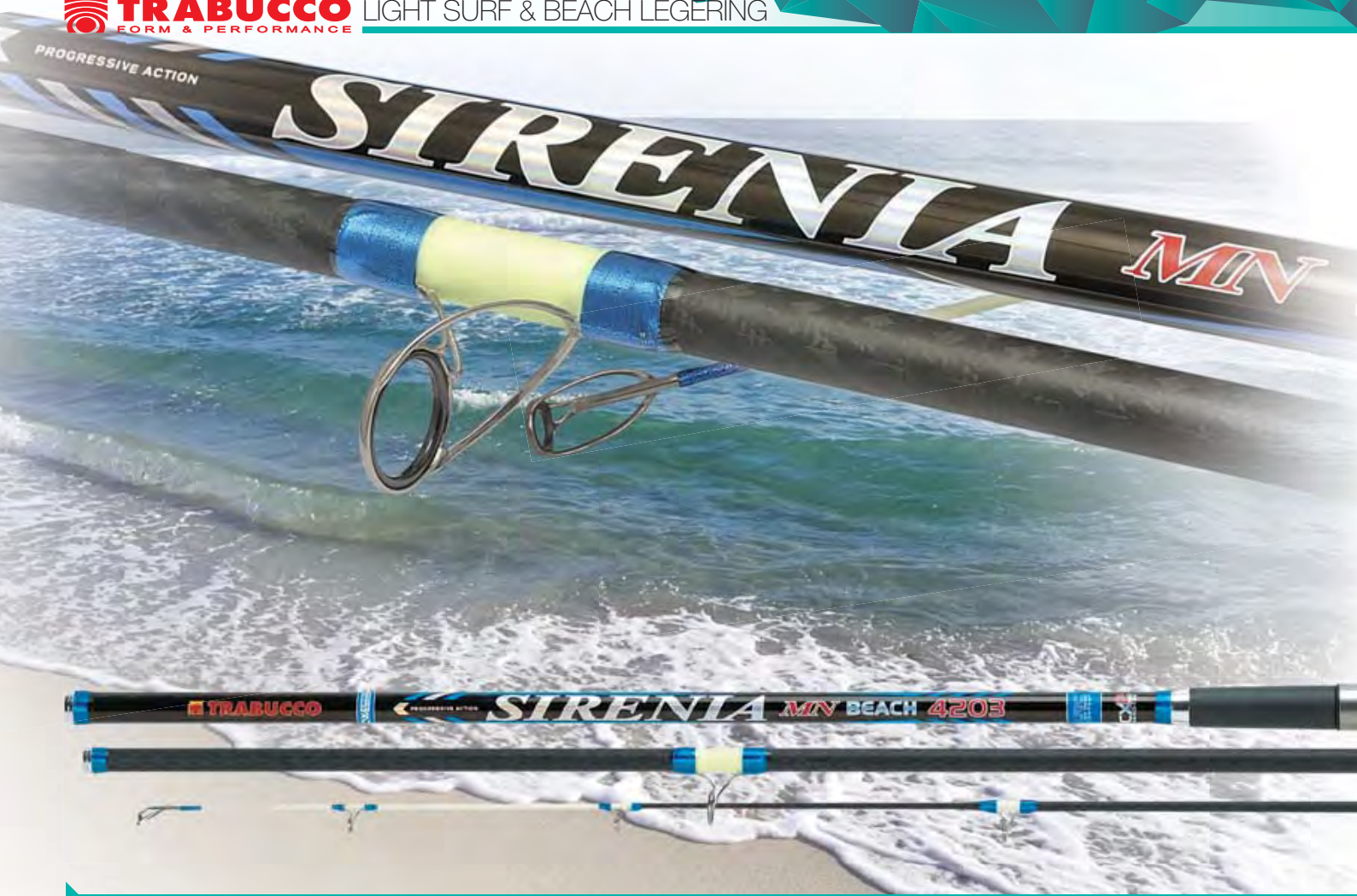

**NEW** CEPHALONIA BEACH

**FAST REACTION BLANK**  
X-TBA CASTING PERFORMANCE

**X JOINT**

**LRC**  
LOW RESIN CONTENT

**Zero**  
residual oscillations

**Fuji** **CX2**  
CARBON NANO-TEK

A perfect action curve, free from dead spots. It's the first effect of the high technology Trabucco X-Joint, in which the carbon sheet is wound at 45°. But the secondary effect, not visible, is the drop of the residual oscillations at the end of the cast, which translates into greater distance reachable. But that's not all. The series is structured by CX2 High Modulus carbon with low resin content, it is proposed with two interchangeable tips: Light, fiberglass (20-50 g) and Heavy, carbon (50-100 g), and fits high quality components. Sea Guide SiC

guides and Fuji NS-7 reel seat, both resistant to saltwater aggression. The intermediate sections have the satin finish that prevents line sticking in wet conditions.

Code	Size	C.Length	Sections	C.W.	Guide
170-85-100	4.60	144	5+2	110	Sea Guide SiC
170-85-200	5.00	144	5+2	90	Sea Guide SiC

FEATURES

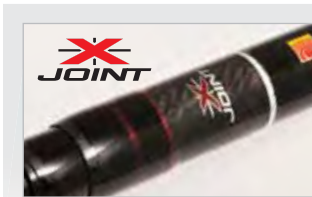

All joints are made under X-Joint technology in order to maximise performances and obtain perfect actions.



PacBay quality reel seat, great reliability and fitted upside down to grant high resistance to extreme pulls.

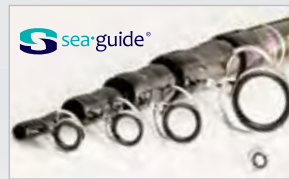

PVD treatment makes SeaGuide SiC guides super resistant to saltwater corrosion.



Supplied with rubber protective cap and two different tips: one made from carbon, the other from fiberglass.



# SIRENIA MN

**FAST REACTION BLANK**  
X-TRA CASTING PERFORMANCE

**CROSS WINDING**

**TITANIUM GUIDE**

**Zero Friction**

**Fuji**

**CX2 CARBON NANO-TEK**

Innovative 3 sections blank designed to provide a rod with single tubular tip showing great sensitivity. The rod is extremely light due to the use of the CX-2 Nano Tek Carbon and its bending curve is progressive and reactive enough to get casting performance very close to stiffer surf casting rods. This is really an outstanding example of good engineering, where Trabucco team put on the table his own fishing experience along with know-how in selecting the best materials and details. Components are at top level and include SiC Sea Guide guides with titanium corrosion free frame, Fuji Gold reel seat and Trabucco aluminium/

rubber butt cap.

Code	Size	C.Length	Sections	C.W.	Guide
170-94-420	4.20	144	3	100	SiC
170-94-450	4.50	157	3	100	SiC
170-94-500	5.00	170	3	100	SiC

## FEATURES



**TITANIUM GUIDES**  
The inner stone, made of SiC, is the best you can get in term of smoothness, heat dispersion and abrasion resistance. But the strongest point of the new Titanium guides is undoubtedly the stiffness and the lightness of the frame. Titanium

is also salt water resistant, so this material has incredible properties indeed! A rod equipped with Titanium guides will always have superior performance because the action of the blank will not be influenced by the weight of the guides.



**FUJI GOLD REEL SEAT**  
You cannot avoid to use a Fuji equipment when you want a first quality accessory for your rod. Surf Casting anglers usually mistreat their rods, using them in an aggressive environment and in extremely tough conditions. The Fuji Gold reel seat is the best you can get in terms of longevity and safety, always keeping your reel right into its position without any problem for years and years.



### BUTT CAP

The Sirenia is an outstanding rod that is light and robust. That's why we decided to equip it with a rubber Butt Cap. The rubber sort we used is extremely tough, standing against abrasions and salt water, but it is also extremely light. To some people it can seem a worthless detail but, on the contrary, it is icing on the cake. And we love to take care of our products, even in the smallest details.



## X-RIDE BEACH

**NEW**

A super concentrate of technologies, filtered by direct experience and highlighted by a brilliant design, because fishing with an X-Ride Beach must be pleasant beyond the pure technical functions. Configured and super tuned for beach legering, this reel has a calibrated capacity tapered spool, with the upper lip profiled to offer minimal friction to the flowing line. Fully treated against corrosion, it has the drag box sealed to keep out dust and water, fits stainless steel ball bearings and main shaft, while the Worm Shaft deals with crossed line lay. To avoid accidental overturn during the more energetic casts, the bail arm can only be closed manually.

**SPECIAL BEACH**



Find out more on page 179



## XANDRIA MN BEACH

3 sections Beach Legering rod equipped with 2 put in sensitive tips made of solid carbon. The new Xandria project has been developed with the supervision of Giuseppe Alesi, famous light surf Italian champion, to achieve a perfectly balanced and light blank, able to cast at distance. The Xandria has a very fast action that is perfect for smooth or just rough sea, when it can still cast at distance with relatively light leads. Equipped with corrosion free SiC guides.



Ergonomic graphite screw reel seat with steel lower hood. Special rubber butt grip with soft, rounded cap.

Code	Size	C.Length	Sections	C.W.	Guide
171-79-420	4.20	144	3+2	100	SiC
171-79-450	4.50	155	3+2	100	SiC



Giuseppe Alesi



Two interchangeable carbon quiver tip:  
stiff / red  
yellow / medium



## FOLGORE BEACH

The Folgore Beach Casting features a very small diameter, super balanced blank. The diameter of the blank of the 4.50 model at the reel seat is just 20mm, and for the 4.20 is as small as 18mm. So the Folgore is the rod you must choose for all the finesse fishing techniques from the beach, with smooth and just rough sea, when it is able to present the baits at a good distance and great accuracy. The blank is made of super high modulus CX-1 carbon and it is strong enough to fight big gilt-head bream. It is equipped with 2 solid carbon put in tips for different casting weights and with stainless steel frame SiC guides. Great value for money.



Two solid carbon interchangeable tips: red (stiff), yellow (medium).

Code	Size	C.Length	Sections	C.W.	Guide
171-76-400	4.00	137	3+2	100	SiC
171-76-420	4.20	144	3+2	100	SiC
171-76-450	4.50	155	3+2	100	SiC



## ACCESSORI SURF

The umbrella, the Surf Box with handle and wheels, plus the bucket are useful accessories for both match and pleasure angler.

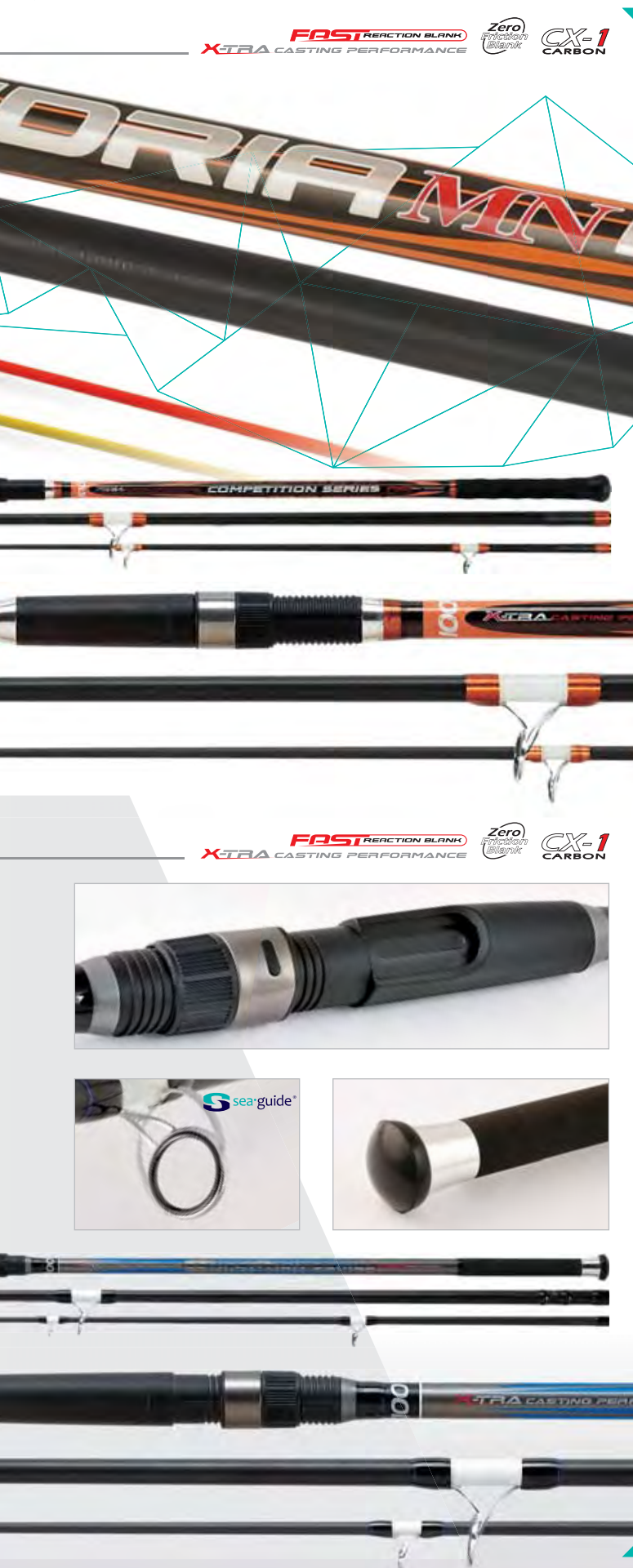

Find out more on page 335

# FLAME



**NEW** FLAME XTREME BEACH

SENSI TOUCH Zero Friction Carbon CX1 MICRO-PITCH

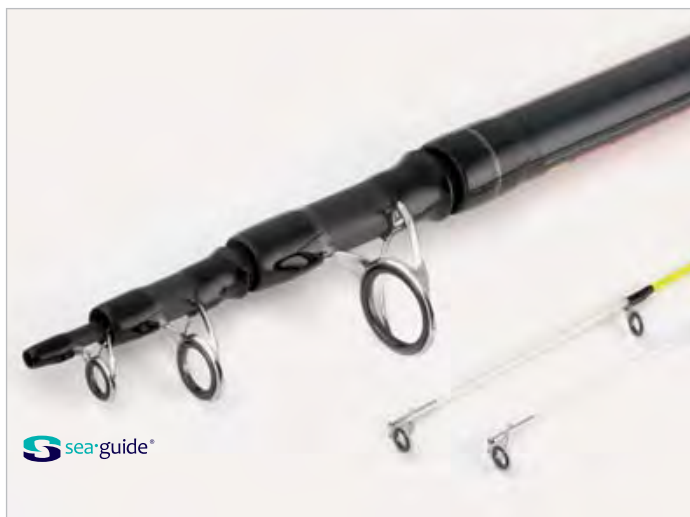

Extremely aggressive in the dressing and in the body, thanks to advanced cosmetics and construction in High Modulus carbon CX1 Micro Pitch, so tightly wound that it reacts like a spring. Thus the rod responds to the loading by multiplying the force, to allow the achievement of long distances, with remarkable precision.

Both rods are equipped with two interchangeable carbon tips: Light (20-50 g) and Heavy (50-100 g). The first is perfect for less demanding conditions or for Striped Sea Bream fishing; the second deals very well with more energetic waves, hunting for White Bream and Gilt Head Bream. The intermediate sections have the Zero Friction finish that prevents line adhesion in wet conditions, resulting in a fluid flow through guides, to the benefit of long range. Sea Guide salt-proof SiC guides and ergonomic graphite reel seat.

Code	Size	C.Length	Sections	C.W.	Guide
171-80-420	4.20	125	4+2	100	SiC
171-80-450	4.50	142	4+2	100	SiC



## LOCUSTA TEKNO MORMORA

True fast action Beach Ledgering blank, able to cast small weights up to 100 grams beyond the 100 meters mark. The CX-1 High Modulus Carbon blank has a tip action that is able to absorb the biggest fish runs, avoiding to break the smallest diameter hooklength. Due to the very light weight, it is the perfect rod for active fishing, that is keeping the rod in hand, slightly trolling the bait over the sandy or muddy bottom to tease fish reaction. The extra sensitive tip allows to detect even the shiest bites. SiC guides.

**XTRA** CASTING PERFORMANCE **FAST REACTION BLANK**

Zero Friction Blank

**CX-1** CARBON

Code	Size	C.Length	Sections	C.W.	Guide
171-66-420	4.20	123	5	100	SiC

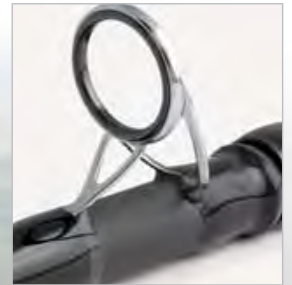

## AEGEAN PROGRESS SURF

**SENSI TOUCH** Zero Friction Blank **CX-1** CARBON



Rod made from CX-1 high modulus carbon, displaying by a remarkably tip action. This rod, although having a very competitive consumer price, offers an action that closely follows the one of the most prestigious series, so it can surely cope with any sea and wind conditions. The tool is completed with excellent corrosion resistant guides, with a practical ergonomic reel seat and a screen printing of high impact.

Code	Size	C.Length	Sections	C.W.	Guide
171-33-420	4.20	150	6	130	SiC

## AEGEAN PROGRESS BEACH

**SENSI TOUCH** Zero Friction Blank **CX-1** CARBON



Magnificent telescopic rod for Beach Ledgering featuring two solid carbon put in tips. The fast reaction blank has been made from High Modulus CX-1 Carbon and its diameter is very thin, even if it is also very good for long casting action. Max power is 100 g, but, taking advantage from the two tips, you can actually fish from 20 to 100 g without any problem. The Aegean Progress Beach has a high class finishing, with Sensi Touch butt section and Zero Friction Blank painting. Ergonomic graphite reel seat, SiC single leg guides and rubber butt grip with fighting cap are nice additions.

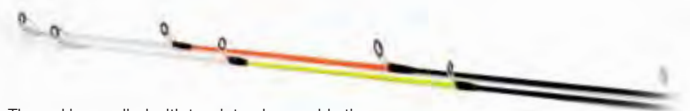

The rod is supplied with two interchangeable tips.

Code	Size	C.Length	Sections	C.W.	Guide
171-65-420	4.20	125	4+2	100	SiC

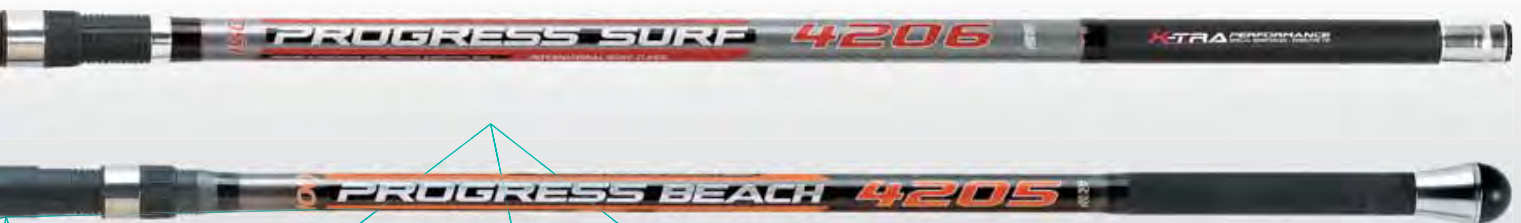

**NEW** DEYLAN MORMORA

Lightweight, compact in the closed length, well balanced, is the most sensitive among the Deylan family, and is designed to cast up to 100 grams weight, the exact range of classic Striped Seabream fishing. His solid carbon tip is painted in white to highlight the bite even in low visibility conditions. The blank is structured in High Resistance carbon for reliability and durability. Double leg SiC guides; screw reel seat with stainless steel hoods. Combined with the Deylan reel it forms a perfect kit.

**FAST REACTION BLANK**  
XTRA CASTING PERFORMANCE  
CROSSED REINFORCED



Code	Size	C.Length	Sections	C.W.	Guide
169-21-400	4,00	123	5	100	SiC

**NEW** DEYLAN MASTER BEACH

With a balanced weight/power ratio, the Master Beach is the intermediate step in the family of Deylan telescopic surf rods, which are destined to the pleasure angler. The resistance of the carbon blank makes it also suitable for bottom fishing from the cliffs, where it is not uncommon to force to safely put a good fish in the landing net. The solid carbon tip does the important job of reporting bites, while the SiC guides

protect the line during retrieve, avoiding overheating which would shorten its life.

**FAST REACTION BLANK**  
XTRA CASTING PERFORMANCE  
CROSSED REINFORCED

Code	Size	C.Length	Sections	C.W.	Guide
169-22-400	4,20	124	5	120	SiC



SEATALISMAN BEACH MASTER

Two rod's series for Beach Legering. The casting vocation of the Sea Talisman, whose casting power is max 100 grams, is enhanced by the Zero Friction blank finishing. Available in two versions, 4.00 and 4.20 meters, with the latter very good for competition purposes. The light weight and reliable blank is made from High Modulus CX-1 Carbon, one of the finest carbon fibres in the market nowadays. The non slip handle is covered by the special Sensi Touch varnishing. SiC guides.

**FAST REACTION BLANK**  
XTRA CASTING PERFORMANCE  
**SENSI TOUCH**  
Zero Friction  
CX-1 CARBON

Code	Size	C.Length	Sections	C.W.	Guide
171-62-400	4.00	145	5	100	SIC
171-62-420	4.20	159	5	100	SIC

ADMIRAL MASTER BEACH

Lightweight but powerful, the Admiral Master Beach is made from crossed reinforced carbon for extra reliability. The blank is telescopic in 4 sections, with 2 interchangeable tip sections with different casting power and action, max casting weight 100g. The two tips are essential in all those situations when instead to change your rod it is more easy, and less expensive, just to change the tip in order to adapt your technique to the changed conditions. The lighter tip can also be used in combination with feeder and maggots. This rod is extremely eclectic and versatile, and should never miss in the bag of the passionate beach angler.

zero Friction  
CROSSED REINFORCED  
S.H.M.R. CARBON



Code	Size	C.Length	Sections	C.W.	Guide
171-64-400	4.00	121	4+2	100	SiC

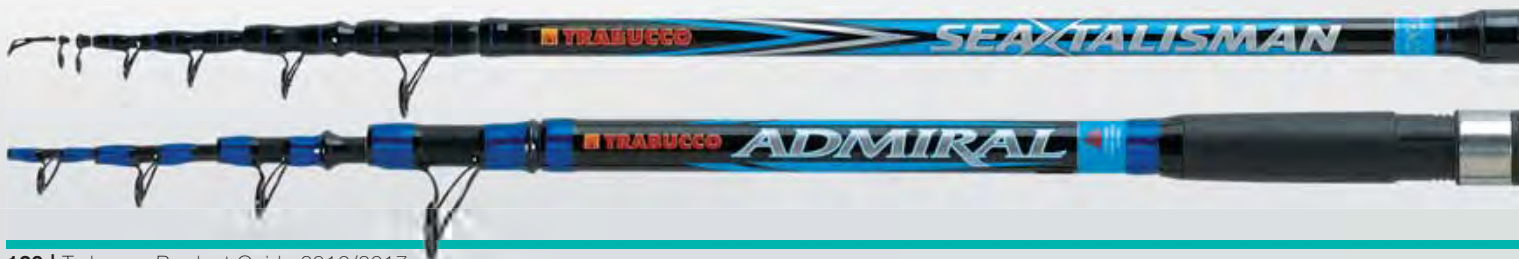



## FINGER PROTECTOR



Our Finger Protector is a small but really important accessory who can't miss in the tackle box of any beach caster. Even when casting at extreme distance with heavy lead your finger will be safe, no more injury on your finger. The sensitivity will not be effected as we have used a very soft fabric, and the soft neoprene cuff can fit to any size of wrist.

Emiliano Tenerelli

Find out more on page 334

## DEYLAN SURF

Being the perfect partner for Deylan surf rods, this reel looks particularly attractive due to body's compactness, which makes nice contrast with tapered spool's width: typical characteristics of high quality surf casting reels.



**SOS** SLOW OSCILLATION SYSTEM

**WGS** WORM SHUNT GEAR Super Balance System

**ONE WAY CLUTCH** **AS** ROLLER ANTI-TWIST SYSTEM

Find out more on page 187





# TELEBOAT RODS

From tackle point of view, boat fishing is a mix of tradition and evolution, with a wide background and, at the same time, a strong potential for wide growth in the whole Mediterranean Sea. Rods must be first of all reliable, then adapted to local needs, then nicely priced, and all these are fields in which the Trabucco engineering is naturally

succeeding, thanks to an advanced technology and thanks to the attention about the finest details in term of action and components. Great results are waiting for you: just go out with your boat and be sure that everything will be easier with these fantastic rods.

## ASTORE SEA POWER



Three telescopic boat rods for light drifting with some great properties: extremely thin talons, amazingly sensitive and with a perfect action. They are so a nice mix of technology, innovation and experience, supported by a CX-2 Nano Carbon Tek material. The blank is thus really powerful but always balanced and light weight. The blanks are built in 6 sections plus 2 put in tips, one in solid carbon and one in solid fibreglass, both coming with guides. The fibreglass tip has been chosen for pelagic fishes such as: bonito, mackerel and little tunny. The carbon tip is more indicated for bottom fishing with weights from 30 to 200 g for other kind of

fish: grouper, snapper, conger and sea bream. Equipped with SiC stainless steel double leg guides. The three sections above butt are adjustable to allow the user adapt the rod's length to fishing conditions.

Code	Size	C.Length	Sections	C.W.	Guide
162-20-100	5.00	143	6+2	100	SiC
162-20-200	5.00	143	6+2	200	SiC
162-20-300	5.00	143	6+2	300	SiC



Saverio Rosa

## NEW VANADIA XT TEKNO BOAT



Series developed to face a wide range of situations in the boat fishing, not just the medium-heavy bottom fishing, since the lead weight limit of 200 grams, but also light drifting. To manage these shifting, there is the responsiveness of CX1 Micro Pitch High Modulus carbon, in which top area sections show a progressive action, assisted by the two interchangeable fiberglass tips. The handle is comfortable and easy to clean, thanks to Sensi Touch finishing; the screw reel seat is practical and safe; double leg guides with SiC ring to allow the use of braided lines. A tool particularly appreciated by those anglers who like the "no limits" rods, which allow them to also use very long rigs. It's the ideal rod when it comes to tempt Snappers and Groupers with a slice of sardine on the hook. The Vanadia XT Tekno Boat is excellent to force and quickly remove from the bottom large hooked predators, avoiding the hooklinks to rub against sharp rocks and soft corals that would endanger the success of the fight.

Supplied with 2 interchangeable tips.

Code	Size	C.Length	Sections	C.W.	Guide
162-23-400	4.00	149	6+2	30-200 g	SiC





Saverio Rosa



sea guide®

Fuji LS stainless steel reel seat. Two interchangeable tips: one made from solid carbon, the other in solid fibreglass, both carefully wrapped with guides.



## NEW VANADIA XT BOAT

SENSI TOUCH  
CROSSED REINFORCED  
high precision control  
2 FLEX TIP  
CX-1 CARBON  
MULTI LENGTH SYSTEM

Light, stiff, highly technical rods displaying a great quality/price ratio, perfect for medium-light bottom fishing but also for all the techniques of light drifting, aimed to catch valuable fish species. The use of CX-1 Micro Pitch carbon allowed Trabucco engineering to obtain rods with stiff yet progressive blanks. Impeccable action allows you to manage in the best way the fishing on the drop, with sardines as hookbait, placing them in the feeding trail. Double leg guides, with SiC rings, are also keen to braided lines. The two interchangeable fiberglass tips allow to perfectly combine both the needs of bottom fishing carried out with medium weights, and those of light drifting for White Bream, Gilt-head Bream, Snappers, but also Bonitos and Little Tunny.



sea guide®



Supplied with 2 interchangeable tips.



Code	Size	C.Length	Sections	C.W.	Guide
162-24-350	3,50	120	5+2	0-120 g	SiC
162-24-400	4,00	120	6+2	0-120 g	SiC



## VANADIA POWER ROCK



Telescopic rod dedicated to rock fishing, boat fishing and livebait bolementino. The full CX Nano Carbon blank provides to this rod a perfect balance, perfectly combined to the extreme power. This allows you to lift and land even the bigger fish and to face extreme fighting without any problem. All components are quite strong and saltwater proof, from double leg SiC guides to the plate reel seat with rubber support. The telescopic top section is made from solid carbon and painted in fluo orange for bite detection. Length is adjustable, thanks to the rubber device on section above butt.



Code	Size	C.Length	Sections	C.W.	Guide
162-48-450	3.50/4.50	148	6	200	SiC
162-48-550	4.50/5.50	153	7	200	SiC

## VANADIA MASTER SEA



Telescopic rod's series made from CX-1 Carbon with special reinforcement on the joints and in the more stressed sections. These rods feature a well balanced blank with fast action. Available in two different sizes (4 and 5 meters), both have a system which allows to block the upper section of the butt that makes them very versatile and therefore suitable when fishing for Sea Bream, Mackerel and Bonito. All the rods have two interchangeable solid tips with different power, saltwater proof guides and non-slip handle.



Two different power interchangeable tips.

Code	Size	C.Length	Sections	C.W.	Guide
162-47-500	4.00/5.00	130	5+2	300	SiC



## ATTRACTIVE BOAT MASTER



Power and control: two words summarize the features of this perfect instrument for the bolementino fishing. A maximum casting weight of 300 grams in a four meters rod, built in four sections with two interchangeable solid tips. Originally designed for a medium heavy bottom fishing at good depth, this rod takes advantage from the total length of four meters to be also excellent for light drifting, of course using large diameter lines

to handle fights in total safety. The blank is made from CX-1 carbon and has a cross reinforcing carbon braid that makes it a secure and perfect partner in any fishing situation. Fitted with SiC stainless steel frame guides.



Code	Size	C.Length	Sections	C.W.	Guide
162-46-400	4.00	140	4+2	300	SiC



## ATTRACTIVE ADRIATICA

Beautiful rod for boat and light drifting. The CX-1 high modulus carbon blank is stiff and progressive, allowing to manage every situation of fight, even when using low diameter lines with a big fish pulling on the other side. It can be used and actually enjoyed while fishing with the rod always in the hand, thanks to the super balanced and light weight blank. All guides are double leg SiC and the rod's length is adjustable, allowing two length for better fishing action. It features two interchangeable tips of different action.



# HAWS ALBACORE



Power, rigidity and lightness are the main characteristics of this rod, which is without doubt the best on the market in this category. A rod built without any compromise made from CX-1 carbon, strengthened by high modulus carbon yarn wrapping. The handle is made by a rubber shrink tube process for perfect control during the casting and the fight.



The section above butt fits a rubber device to adjust length at one metre shorter. Three interchangeable solid tips allow to adapt rod's sensitivity to fishing conditions. A recommended sea rod for Bonito, Sea Bass and Mullet.



Code	Size	C.Length	Sections	C.W.	Guide
162-41-500	4.00/5.00	142	5+3	5-150	SiC
162-41-600	5.00/6.00	152	6+3	5-150	SiC



# SEATALISMAN TEKNO BOAT



This is a perfect combination between a bottom fishing boat rod and a light drifting rod. Action is medium heavy and can be used for fishing snappers and groupers. With these species of fish it is key to be able to counter fight the initial run in order to avoid the breaking the line on bottom rocks. The whole blank is so active during the fight, with a sensitive tip that detects the bites and powerful lower sections that will tire the fish. The starting guide is double leg, while all the other are single leg, to have a better action and lighter weight. The Sea Talisman features two different interchangeable tips, one is made from solid glass while the other is made from solid carbon; the components resistant to corrosion, with graphite reel seat and stainless steel frame SiC guides.



Code	Size	C.Length	Sections	C.W.	Guide
162-61-400	4.00	130	5+2	150	SiC



Code	Size	C.Length	Sections	C.W.	Guide
162-30-500	5.00	120	7+2	10-100	SiC



In dotazione due vette intercambiabili ad innesto.



Saverio Rosa

## AEGEAN TELEBOAT



Supplied with 2 fiberglass tips.

An high grade rod offered at reasonable price, developed for medium-heavy bolentino with 250 grams casting power. With a powerful but progressive action, this rod is particularly suitable for bottom fishing at depths of up to 60 meters. A rod built without any compromise, made from CX-1 carbon and strengthened with the carbon Cross Winding to provide power, balance and sensitivity, everything associated with an exceptional lightweight. The rod is supplied with two tips showing different power, and features salt water proof guides plus non-slip handle.

Code	Size	C.Length	Sections	C.W.	Guide
162-53-320	3.20	115	5+2	250	SiC

## DEYLAN SEA POWER



Super nice action and greatly handy, the Deylan Sea Power is a telescopic rod for boat deep sea fishing. It can deal with leads up to 400 g and fight good sized preys. The super high modulus CX-1 carbon is very reliable and stiff enough to provide a perfect sensitivity, while the bite detection job is perfectly done by the telescopic solid glass tip. The Trabucco team use this rod for deep sea fishing with live bait or dead natural bait. The double leg SiC guides allow the use of braided lines. Ergonomic graphite reel seat with aluminium hood.



Code	Size	C.Length	Sections	C.W.	Guide
162-63-300	3.00	115	5	400	SiC

Telescopic solid fiberglass tip.

## DEYLAN MAX DEEP



Ergonomic graphite reel seat. Double legs guides with protective O-rings.

The Deylan Max Deep is a telescopic rod with an extremely stiff blank, made from CX1 low resin content carbon, which is perfect for boat fishing in deep water (70-100 m). The whole structure of the blank is able to manage heavy lead, while still keeping high sensitivity. This rod is equipped with 2 fiberglass put in tips (Light and Medium) for use with different weights and making possible to use it for fishing in shallow water too. Double leg stainless steel frame SiC guides and ergonomic graphite reel seat with aluminium hood.



Code	Size	C.Length	Sections	C.W.	Guide
162-62-300	3.00	110	4+2	250	SiC
162-62-340	3.40	110	5+2	250	SiC

## SOLARIS PRO BOAT



Code	Size	C.Length	Sections	C.W.	Guide
162-59-300	3.00	112	4+2	200	SiC
162-59-360	3.60	118	5+2	200	SiC

Beautiful rod for boat fishing, dedicated to those who look for a value rod that can be used with different techniques. It features a full high modulus CX-1 carbon blank, reinforced by a double wrapping of high resistance carbon to withstand the most severe shocks. Available in sizes of 3 and 3,60 metres, it excels in both bottom and midwater fishing, where you can enjoy its action fighting with mackerel, horse mackerel and chub mackerel. Obviously, this wide range of use, which means that it is possible to fish with leads ranging from 10 to even 200 grams, can be obtained not only through fanatical designing attention, but also through the use of two different action and power fibreglass tips that are provided upon purchase. The handle is non-slip and guides are SiC with double leg. Tips are one legged guided.

## SOLARIS SPECIAL PALAMITA



Developed in cooperation with Adriatic sea experts to get the best light drifting rod. You will be impressed by this rod that will allow you to use thinner lines than other rods, thanks to the perfect curve of the high modulus CX-1 carbon blank, which is fully reinforced

to grant high resistance to shocks. Guides have been chosen and positioned according to the most advanced competition rods: first guide only is double leg. The fibreglass solid tip al-

lows a super sensitivity and great reliability in tough conditions.

Code	Size	C.Length	Sections	C.W.	Guide
162-28-400	4.00	135	6	10-80	SiC

## SEARIDER TELEBOAT



These rods feature a blank made from High Resistance carbon, which makes them extremely strong and lightweight, keeping an unrivalled progressive action and sensitivity. All of these rods have been made to offer the maximum control of the fish while fighting. Incredible power in the butt to manage fish even when

they are bigger than expected!

Code	Size	C.Length	Sections	C.W.	Guide
160-16-180	1.80	100	3	200	SiC
160-16-210	2.10	100	3	200	SiC
160-16-240	2.40	106	4	200	SiC
160-16-270	2.70	106	4	200	SiC



# SONIC

The endless list of different coast shapes and natural environments offer fantastic chances to the boat angler, but also causes the need of a vast range of dedicated rods, as tackle should be adapted to depth and sea conditions. For such reason Trabucco continuously develops wide and complete families of rods like Sonic.

## SONIC XS TEKNO

The composite fiber blank of the Sonic XS Tekno is well balanced and shows the perfect action to fish for small and medium pelagic, such as mackerel, scad, bogue etc. But the blank is strong enough to fight with bigger predators as bonito and skipjack. The SiC guides feature a corrosion free stainless steel frame.



Code	Size	C.Length	Sections	C.W.	Guide
168-39-180	1,80	92	3	10-100 g	S-SiC
168-39-210	2,10	92	4	10-100 g	S-SiC
168-39-240	2,40	102	4	10-100 g	S-SiC



## SONIC XS BOAT



High resistance composite blank rods engineered in short section to be easily stored onboard. Strong blank but still sensitive thanks to the solid fibreglass tip. S-SiC guides can be safely used in combination with braided lines.

Code	Size	C.Length	Sections	C.W.	Guide
168-42-165	1.65	82	3	120	S-SiC
168-42-195	1.95	85	3	120	S-SiC
168-42-225	2.25	85	4	120	S-SiC

## NEW SONIC XT BOAT

The ideal rod for anyone who starts moving in the world of bottom sea fishing. The low price does not hide any minor solution, so that the carbon-fibreglass composite blank is unrivalled in terms of resistance, while the nylon tip, built-in the telescopic structure of the rod, is ultra-sensitive and able to trick the most critical fish bites. Double leg S-SiC guides with stainless steel frame, plus screw reel seat complete the features. Excellent to fish for Gilthead Bream, Seabream and more, it's ideally suited to several conditions of sea fishing from the boat.

Code	Size	C.Length	Sections	C.W.	Guide
168-48-210	2,10	98	3	20-150 g	S-SiC
168-48-240	2,40	102	4	20-150 g	S-SiC
168-48-280	2,80	105	4	20-150 g	S-SiC



## SONIC DEEP MASTER

High resistance composite blank for deep sea fishing. Strong body with sensitive solid fibreglass tip. It will not a surprise if the Sonic Deep Master will help you to catch very big fish from the deep under your boat.

Code	Size	C.Length	Sections	C.W.	Guide
168-40-150	1.50	100	4	150	S-SiC
168-40-180	1.80	100	5	150	S-SiC
168-40-210	2.10	100	5	150	S-SiC

## NEW SONIC XT POWER

Powerful telescopic series destined to hard boletino, typical of high and uneven seabeds as well as shipwrecks areas. The carbon-fibreglass composite blank is able to counteract the reaction of strong fish and to lift from the bottom of the larger ones. Bite detection is guaranteed by a powerful but sensitive top section, made from solid nylon and built-in telescopic structure of the rod. Fitted with double leg SiC guides and robust screw reel seat.

Code	Size	C.Length	Sections	C.W.	Guide
168-49-240	2,40	100	4	50-200 g	S-SiC
168-49-270	2,70	105	5	50-200 g	S-SiC





Ergonomic graphite screw reel seat with steel moving hood. Telescopic tip, made from solid fibreglass. Butt cap directly screwed into butt section's wall.



# TRITON



## TELEBOAT & DEEP SEA



Definitely boat fishing is one of the most popular style of fishing, and it is typically done using medium length rods, light but still rigid enough to be able to fight fish that are often of a very interesting sizes. The Triton rods have been created to meet this need about easy to use, effective and affordable rods. The blank is made from Composite Power Fibre and can be used with up to 150 grams lead for the Deep Sea and 200 grams for the Teleboat, both being able to fight and pull big fish from the bottom of the sea, while the top nylon multicolor tip is surprisingly very sensitive and strong at the same time. Triton are equipped with double leg S-SiC guides and non-slip grip butt section.



Code	Size	C.Length	Sections	C.W.	Guide
160-36-210	2.10	100	3	150	S-SiC
160-36-240	2.40	100	4	150	S-SiC
160-36-270	2.70	100	4	150	S-SiC
160-36-300	3.00	100	5	150	S-SiC



Code	Size	C.Length	Sections	C.W.	Guide
160-38-210	2.10	101	4	200	S-SiC
160-38-240	2.40	101	4	200	S-SiC
160-38-270	2.70	105	4	200	S-SiC



# VEKTOR

*Bolentino is surely one of the most antique boat fishing style, well known all over the Mediterranean sea since the stone age, when it was done holding the line over the fore finger to detect the bite. Nowadays, the sport has moved forward with rod and reel, but the vast range of fish species which can be caught is still the same, including sea bream, cod, conger eels in case of bottom fishing, then mackerel, bonitos and blue fish when fishing midwater. The ideal rod? A Vektor by Trabucco, of course!*

## VEKTOR BOLENTINO



Wide family of rods designed for light, medium and heavy boat fishing. We paid a lot of attention to create these models, in order to get a stiff and reliable blank and a supersensitive action, using a fibreglass tip. The rods are equipped with braided friendly S-SiC guides with stainless steel frame, extremely resistant to salt water.

Code	Size	C.Length	Sections	C.W.	Guide
168-45-150	1.50	75	3	80	S-SiC
168-45-180	1.80	90	3	80	S-SiC
168-45-210	2.10	90	4	80	S-SiC
168-46-150	1.50	75	3	100	S-SiC
168-46-180	1.80	90	3	100	S-SiC
168-46-210	2.10	90	4	100	S-SiC
168-47-150	1.50	75	3	150	S-SiC
168-47-180	1.80	90	3	150	S-SiC
168-47-210	2.10	90	4	150	S-SiC



Saverio Rosa

## VEKTOR SARAGO



Complete series of rods for inshore boat fishing with crossing reinforced blank made of powerfibre. Virtually unbreakable, these rods can stand epic fight and efforts. S-SiC guides are saltwater protected and can be used both with monos or braided lines. The high visibility fibreglass tip is ultra sensitive.

Code	Size	C.Length	Sections	C.W.	Guide
168-34-180	1.80	74	4	120	S-SiC
168-34-210	2.10	90	4	120	S-SiC
168-34-240	2.40	90	5	120	S-SiC

## VEKTOR DORADA



This the true classic telescopic boat rod for Mediterranean Sea fishing. Light weight, sturdy and really sensitive, this rod delivers hours and hours of pure fishing fun and still be able to fight against pretty big fish. The butt handle is covered by soft EVA and include a strong screw reel seat. The telescopic tip is made from solid fibreglass to provide sensitivity and strength at the same time.



Code	Size	C.Length	Sections	C.W.	Guide
168-37-180	1.80	63	5	50-150 g	S-SiC
168-37-210	2.10	69	5	50-150 g	S-SiC





## TACKLE BOX SYSTEM

Finally everything finds its own place on the boat, thanks to the fantastic Rapture tackle box! Made from stiff plastic material, which is quite strong and resistant to any temperature, this new product allows storing all bits and pieces we need for a fishing session on the boat, which find their safe place in a myriad of adaptable compartments within the three clear drawers with different depth. They are accessible from the front tilt cover, which can become a convenient counter while preparing the rigs. Snelled hooks, ready rigs and sabiki rigs have their own space, with a dedicated shell cover for easy access. All angles are rounded to avoid snagging the line. The sturdy handle folds completely and disappears in the dedicated recess.



Find out more on page 315



## CORSARO SPECIALE SGOMBRO



Powerfibre blank new series, powerful and balanced, designed for fishing between surface and bottom targeting mackerels and horse mackerels from the boat. The Corsaro is so sensitive to allow to detect the more tender bite, thanks to the high visibility super sensitive fibreglass tip. It can be used with a wide range of weights, virtually from 10 to 100 gr. S-Sic salt water resistant guides can be used with braided lines.



Code	Size	C.Length	Sections	C.W.	Guide
168-32-210	2.10	90	3	100	S-SiC
168-32-240	2.40	90	4	100	S-SiC
168-32-270	2.70	100	4	100	S-SiC

## CORSARO DEEP SEA



Super strong telescopic boat rod built to last. The extremely stiff blank, made with Powerfibre is able to fight even with big fish and force it out of heavy cover, such as rocks or wrecks. The solid fibreglass tip is sensitive enough to allow you to feel every single bite. All components are salt water resistant.



Code	Lungh.	C.Length	Sections	C.W.	Guide
168-31-150	1.50	80	3	50-150	S-SiC
168-31-180	1.80	80	3	50-150	S-SiC
168-31-210	2.10	80	4	50-150	S-SiC
168-31-240	2.40	87	4	50-150	S-SiC



# BOAT RODS

The rods you'll find in these page are the results of hard engineering work, development and hundreds of hours spent fishing with them. Boat fishing can put under enormous stress a rod and that's why we used just the best materials, reliable

and tested again, to be sure that the rods you're going to purchase will never let you down and will last longer.

## HERAKLION BOAT POWER

A rod made with the latest generation CX-2 Nano-Tek Carbon further reinforced with Cross Winding System. The blank is ultra-tapered for maximum progress when loaded, while the spigots joints are designed to ensure maximum strength and follow perfectly the rod blank action. All the rods have two fiberglass tips with different power, but are both able to cope with the declared rod weight power, original Fuji salt water proof guides, non-slip handle and stainless steel reel seat Fuji LS. A higher-level tool dedicated to the true experts in the boletino.



Original Fuji salt water proof guides, stainless steel reel seat Fuji LS.



## NEW HERAKLION MAX DEEP 1000

SUPER PROGRESSIVE JOINT

CX1 CARBON MICRO-PITCH

Purposely developed for electric reel fishing, it's able to handle sinkers weighing up to 1 kilo at depths between 300 and 500 meters. The CX1 High Modulus carbon provides strength and sensitivity, while the Sea Guide Heavy Duty guides protect the line with their SiC ring, literally perfect with braided lines. Their frame is treated against corrosion by a process called PVD (Physical Vapor Deposition) that covers it at atomic level, thus in a permanent manner. The handle grip is made from high density EVA, with fore grip shaped for a firm hold, incorporates the stainless steel reel seat and ends with the gimbal butt, covered by a rubber cap. A tool designed to catch large deep sea fish, but not only: in fact we will no longer be afraid to increase the volume of the bait to tempt oversized fish as big as White and Brown Groupers, or Conger over 10 kg. The power

of the blank ensures proper management of the battle, even where, in ascent from the bottom, there is a super fighter that would put a strain on any other so-called "classic" tool. The rod is great for all those situations of deep bottom fishing to Red Seabream, Beltfish, Cod, in which, potentially, the big catch is not so rare. Our field testers have tried the Heraklion also in the deep waters of the Atlantic Ocean with results nothing short than amazing.

Code	Size	C.Length	Sections	C.W.	Guide
161-35-270	2,70	140	2	1000 g	Sea Guide SiC



## VANADIA PRO BOAT

A beautiful deep fishing rod medium depth, divided into two sections marked taper, made entirely from high modulus carbon CX-1: an extremely powerful and responsive material. The joint system is very reliable, progressive joint processing eliminates the problem of blocking sections and safeguards the keeping of disconnection. Very stiff and well balanced is characterized by high sensitivity of the two tips provided and for the excellent progress of the blank. Top-level components: "essential" reel seat, Sea Guide Boat rings for maximum performance when using braided lines.





Saverio Rosa



Supplied with 2 fiberglass tips.

Code	Size	C.Length	Sections	C.W.	Guide
161-32-300	3.00	175	2+2	300	Fuji
161-32-500	3.00	175	2+2	500	Fuji



**NEW** HERAKLION PRO DEEP 500



It's a wonderful mix of power and sensitivity, obtained through a wonderful CX1 Micro Pitch High Modulus carbon blank, which in the top area assumes a progressive flexibility, essential for the bite's detection. The rod can be used with fixed spool reel in deep bottom fishing, but also with the electric reel in toughest conditions. The maximum weight usable decreases with the increase of the vertical distance, so at 500 meters the rod has the limit to 500 grams, rising to 750 grams on 300 m and to 1 kilo for a depth of 200 meters. Sea Guide SiC guides feature the frame protected against corrosion by the PVD process (Physical Vapor Deposition). Handle is made from hard EVA, with contoured fore grip, screw reel seat and gimbal butt, protected by a rubber cap. The Pro Deep follows the latest trend regarding fish retrieve from deep water, and is able to satisfy the most demanding Red Seabream anglers.

The classic risks of missing or mouth cutting while rising from the seabed are totally cancelled, thanks to progressive parabolic blank, which absorbs perfectly the typical "heads" that these Perciforms display during their ascent from the depths. The top section provides ultra-sensitive perception of the most timid touches, even at hundreds of meters below our boat. The Heraklion Deep Pro allows you to employ relatively thin lines, thus transforming, as it is well known, a refinement of the lines in a mathematical increase of bites.

Code	Size	C.Length	Sections	C.W.	Guide
161-36-240	2,40	130	2	500-750-1000	Sea Guide SiC
161-36-300	3,00	160	2	500-750-1000	Sea Guide SiC



Supplied with two high sensitive tips.

Code	Size	C.Length	Sections	C.W.	Guide
161-31-300	3.00	140	2+2	250	Boat SiC





**NEW** VANADIA  
TEKNIC SEA

**3 FLEX XTIP** **CX-1**  
CARBON MICRO-PITCH  
**SUPER PROGRESSIVE JOINT**

A fine, balanced, lightweight tool. But such grace shouldn't trick you, because the first impact immediately leaves room to the conviction about holding a deadly weapon, with absolute precision and power beyond imagination. Combine it with a size 6000 Trabucco reel and carry it into the boat: thanks to its structure, made of two equal length sections, it will find room anywhere, and in action it will amaze you with its three interchangeable fiberglass tips. With the ergonomic reel seat and EVA handle, the control is complete; the line flows gently in the endless series of small double-leg guides, with SiC ring. A rod that gives the best of itself in the coastal and medium heavy bolentino on White bream and Sea Bream with the american worm, the korean, bibi, sand worm or shrimp, but it is an unbeatable ally even when targeting Snappers and Groupers on the high seas. A gem that allows you to deal both with relatively thin hooklinks and worms (for this use we will choose the "light" tip among the 3 supplied), or using slices of Sardine with stronger lines (in this case we have the "medium" and "heavy" tips).



Code	Size	C.Length	Sections	C.W.	Guide
161-42-240	2,40	125	2+3	250 g	SiC
161-42-270	2,70	139	2+3	250 g	SiC

EPICA XTREME

**CX-1**  
CARBON  
**SUPER PROGRESSIVE JOINT**



Trabucco designed this rod for all the no-limits fishing lovers, a powerful and reliable tool with two spigot jointed sections. It can be used to fish at any depth and is able to face every fish dwelling down there. Perfect for fishing on deep reefs and wrecks, where big congers, groupers and rocklings grow at bigger sizes. It can be used in combination with electric reels as well. SiC salt water protected guides have been chosen for this rod, since heavy fishing is usually combined with braided lines.

Code	Size	C.Length	Sections	C.W.	Guide
161-41-240	2,40	124	2	Max 400	SiC
161-41-270	2,70	140	2	Max 400	SiC

RUSHWAVE XP BOAT

**X TREME** ACTION **NFC**  
NANO FIBER CARBON



N.F.C. (Nano Fiber Carbon) blank for this all-round high performance boat rod showing a beautiful, progressive curve and a significant power reserve in the lower part of the blank. It can be used with great satisfaction both as a trolling rods, 12-20 lbs class, and as a medium/deep sea bottom rod, thanks to the sensitive tip and general light weight. The long tip is directly inserted into the butt section. The prime grade EVA ergonomic handle is equipped with an aluminium reel seat and gimbal. The lowered frame SiC guides allow a safe use of braided lines.

Code	Size	C.Length	Sections	C.W.	Guide
167-48-210	210	170	1+1	300	SiC

## SEARIDER BOLENTINO



Series of 2 sections versatile boat rods: true allround models that will fit most of the fishing techniques you can use from your boat. The powerful progressive action blank is just perfect and we are offering two casting weight categories in 4 length. Despite the blank's power, the rod is really sensitive, using a fiberglass tip expertly joined to the rest of the rod. The handle is extremely comfortable and is equipped with an EVA Split handle. The S-SiC guides have a stainless steel frame for salt water use.

Code	Size	C.Length	Sections	C.W.	Guide
161-08-180	1.80	100	2	150	S-SiC
161-08-210	2.10	110	2	150	S-SiC
161-08-240	2.40	130	2	150	S-SiC
161-08-270	2.70	140	2	150	S-SiC
161-09-180	1.80	100	2	200	S-SiC
161-09-210	2.10	110	2	200	S-SiC
161-09-240	2.40	130	2	200	S-SiC
161-09-270	2.70	140	2	200	S-SiC

## SEARIDER MAX DEEP



Two sections boat rod, made from Powerfibre and able to stand heavy loads and to properly fish even in deepest waters. The tip is strong and reliable, but still sensitive enough to detect bites down in depth. Despite the powerful blank, the Searider Max deep is balanced and will not tire angler's arm. S-SiC guides can be safely used in combination with braided lines.

Code	Size	C.Length	Sections	C.W.	Guide
161-18-210	2.10	110	2	200	S-SiC
161-18-240	2.40	130	2	200	S-SiC
161-18-270	2.70	140	2	200	S-SiC

## NEW TRITON MASTER ISO



From heavy bottom fishing to surface trolling, this series solves many situations with its reliable structure in fiberglass, made of two sections having equal length. For its employment destination, which involves heavy traction, the reel seat is fitted upside down, while all the SiC rings have the double-leg frame. The handle, covered by high density EVA, ends with a rubber knob that can be fitted into the groin during the fish retrieve. The sensitive top section is painted in orange for optimum visibility. An extremely versatile rod, providing excellent performance in light trolling with small lures to Bonitos, Little Tunny, Horse Mackerel, Saddled Bream, which can be put into action at Squid trolling but also at coastal and medium

depth bolentino to White Bream, Black Seabream, Gilt-head Bream... an ally that is bound to meet up several species of marine fish and shellfish.

Code	Size	C.Length	Sections	C.W.	Guide
165-83-100	1.80	100	2	30-300 g	S-SiC
165-83-200	2.10	110	2	30-300 g	S-SiC
165-83-300	2.40	130	2	30-300 g	S-SiC

## TRITON TEKNO SEA



This is a special series of one piece boat rods built from reinforced Power Fibre. Due to the specific building process, Trabucco succeeded to design a rod that even in 1.20-1.50m delivers the right action and is able to manage at best lures up to 200 g. The Triton Tekno Sea are true salt water rods and are equipped with corrosion free S-SiC braided friendly guides. They are versatile and reliable, and can be used in a number of situations, from classic bottom fishing for different sea bream species to mid water fishing with Sabiki.

Code	Size	C.Length	Sections	C.W.	Guide
165-82-100	1.20	120	1	150	S-SiC
165-82-200	1.50	150	1	150	S-SiC
165-82-300	1.20	120	1	200	S-SiC
165-82-400	1.50	150	1	200	S-SiC

# SEPPIA-CALAMARO-SABIKI

Always at the fore front in new techniques and to help you to improve your catches, here you'll find our latest development about the Eging, Karei and Sabiki fishing.



## KAZUMA MASTER SQUID



New family of extremely light and easy to use squid rods for boat fishing. The blank is equipped by a large number of corrosion free guides that helps to transmit vibrations and improve sensitivity. The super sensitive tip can detect with great precision the squid bites. In evidence the 3 pieces configuration which makes these rods so easy to transport and store, plus the butt grip, which is flattened for easy hold within armpit when jigging.

Code	Size	C.Length	Sect.	C.W.	Guides
160-84-180	1.80	73	3	100	S-SiC
160-84-210	2.10	86	3	100	S-SiC



## KAZUMA MASTER ISO



Based on a parabolic action equipped with many small corrosion free S-SiC guides, these rods are the perfect solution for catching lots of squid. The super slim HVE fibre blank has been specifically designed to manage the typical runs of squids without harming their delicate tentacles.

Code	Size	C.Length	Sect.	C.W.	Guides
160-83-180	1.80	100	2	150	S-SiC
160-83-210	2.10	110	2	150	S-SiC
160-83-240	2.40	130	2	150	S-SiC
160-83-270	2.70	140	2	150	S-SiC

The strong graphite reel seat with steel hoods. The butt grip is flattened and carries Kazuma laser engraved logo.



## TRITON SQUID STICK

These rods offer a wide casting power range, making them suitable for all the squid fishing techniques. The new Triton Squid are long between 1.65 and 1.80m and have been designed for squid fishing. The HRC blank makes them really comfortable, having a very small butt section diameter. They can be used both with small lures, such as Tatakai, and traditional and heavier squid jigs. The super sensitive tip will make the detection of bites far easier.

Code	Size	C.Length	Sect.	C.W.	Guides
165-80-100	1.65	111	1+1	10-80	S-SiC
165-80-200	1.80	131	1+1	10-80	S-SiC
165-80-300	1.65	111	1+1	20-100	S-SiC
165-80-400	1.80	131	1+1	20-100	S-SiC



# KAZUMA

A new range of eging rods designed for squids and sepias from the boat, featuring extremely light and sensitive blanks.



## KAZUMA SPECIAL SQUID

**HVE**  
HIGH VOLUME EPOXY FIBER

Specially developed for Squid fishing, this rod is somehow softer than the Kazuma Master Iso, and is able to manage lures up to 100g. All components are 100% salt water protected, while the blank has been made from High Volume Epoxy Fiber, an high density material which makes it practically unbreakable.

Code	Size	C.Length	Sect.	C.W.	Guides
160-90-165	1.65	87	2	100	SiC
160-90-180	1.80	93	2	100	SiC
160-90-210	2.10	110	2	100	SiC

## KAZUMA SABIKI

**HVE**  
HIGH VOLUME EPOXY FIBER

Made from full S.H.R. Carbon, the special blank of this rod is extremely strong and fast, but the tip is soft and sensitive, able to detect even the most delicate bite. KAZUMA SABIKI features heavy duty wrapping on guides and salt water proof materials, SiC guides and first choice EVA handle for maximum grip and comfort during the most important fight.

Code	Size	C.Length	Sect.	C.W.	Guides
161-07-250	2.50	130	2	100	SiC



## SEARIDER MAX SQUID

Squid fishing from the boat is one of the most amusing fishing techniques...and it can provide an excellent food for dinner! The Searider Max Squid is perfect to fish in any condition, even with strong stream, and it can be used with weights up to 150 g. The super sensitive tip can always do the job.

Code	Size	C.Length	Sect.	C.W.	Guides
161-19-160	1.60	95	2	150	S-SiC
161-19-180	1.80	100	2	150	S-SiC
161-19-200	2.00	110	2	150	S-SiC

**POWER FIBRE**





Saverio Rosa  
Simone Chiariglione

## TROLLING

*When you are boating on the sea and trolling for big predators you cannot make any compromise, otherwise you risk to miss the fish of your life. Our new trolling rods are born to avoid such serious drawback. Our top of the range families are Windrose Titanium, Windrose Pro Fighter and T-Game, and we believe they will become your best allies in the magic moment when the fish of your life will attack your lure.*



## T-GAME

**XTREME ACTION** E-GLASS BLANK

Amongst the Trabucco trolling rods range, the T-game is for sure the most "american" one, both for the components and cosmetic and for the action and consequent class test. The blank is powerful and designed for challenging fishing to fast and pugnacious fish. The 1+1 rods are available in 6' and 6'6" length, all equipped with SeaGuide

SIC guides, stainless steel frame. The anodized aluminium reel seat is a reliable model from Pacific Bay, and carries double screw for total safety. The gimbal is made of anodized aluminium too, and is protected by a removable rubber cap.

## SEALION OB



Offset handle and fore grip are made from EVA. Pacific Bay reel seat.



Sea Guide guides with stainless steel frame and SIC ring.



Slick butt ending with gimbal.

Code	Size	C.Length	Sect.	Power	Guides
167-22-100	6' (1.83)	144	2	12/20	SIC x 8
167-22-200	6' (1.83)	144	2	20/30	SIC x 8
167-22-300	6'6" (1.98)	160	2	8/12	SIC x 9
167-22-400	6'6" (1.98)	160	2	12/20	SIC x 9
167-22-500	6'6" (1.98)	160	2	20/30	SIC x 9



**8+2**  
SS SHIELDED  
BALL BEARING

Sealion OB is a reliable series of trolling reels developed for all those sea anglers who refuse to accept any compromise on quality of their own tackle.

Find out more on page 198

# WINDROSE

The trolling rods Wind Rose Pro-Fighter series are made for those experts who demand a concentration of technology and expertise to their equipments.

## WINDROSE TITANIUM

**XTREME ACTION** **NFC**  
NANO FIBER CARBON

A trolling rods series, dedicated to the hi-tech trolling world, following the requirements of the new saltwater fishing techniques. The superb parabolic action with the ultra fine blank helps to boat the fish in every situation. Built entirely by Nano Carbon Fiber with a Magic Stick technology which ensures sensitivity and durability, the WINDROSE TITANIUM is extremely light and strong; the special SiC guide

assembly helps it to be a very innovative rod. A series of rods of the highest quality multi-purpose properties that make them suitable for a different fishing style as: the downrigger, live bait and guardian triggering. Aluminium reel seat and removable butt represents unrivalled value for money.

### SPECIFICATIONS



The aluminium gimbal butt, the offset slick butt and quality aluminium ALPS reel seat further enrich this rod, which is surely destined to offer great performances.

All rods are fitted with Sea Guide SiC double wrapped guides, perfectly suitable for braided line use.



Code	Size	C.Length	Sect.	Power	Guides
167-26-120	1.95	1.64	1+1	8-12lb	SiC x 8
167-26-200	1.95	1.64	1+1	12-20lb	SiC x 8
167-26-300	1.95	1.64	1+1	20-30lb	SiC x 8
167-26-400	2.10	1.79	1+1	12-20lb	SiC x 8
167-26-500	2.10	1.79	1+1	20-30lb	SiC x 8

## WINDROSE PRO FIGHTER

**XTREME ACTION**



The Wind Rose Pro-Fighter series are made for those experts who demand a concentration of technology and expertise to their equipments. This series of perfect war instruments is presented to the angler in five versions to have the right rod for every situation. Built thanks to an innovative formula of composite material, the PRO FIGHTER Series combines progressive parabolic action, power and lightness. All five models are fitted with SiC guides, so they can be used with braided lines. The series is offered with special guide assembly designed by our experts to increase the already high reserve of power that distinguishes these rods. The aluminium gimbal cup enriches the product for great performance.

Two 6 feet PRO FIGHTER are dedicated to those who want a high performance stand-up. Perfect for fishing with the downrigger (sunk), the pro-fighter 6-foot turn out amazingly handy, and, at the same time, secure and powerful in dealing with the most challenging fights with big amberjack, snapper and grouper. Three 7 feet extremely light and sensitive are specially designed for lead guard fishing style. With their low weight and ergonomic grips, these rods can also be used for fishing with rod in the hand.



Code	Size	C.Length	Sect.	Power	Guides
167-27-120	1.80	1.49	1+1	12-20lb	SiC x 7
167-27-130	1.80	1.49	1+1	20-30lb	SiC x 7
167-27-212	2.10	1.64	1+1	8-12lb	SiC x 9
167-27-220	2.10	1.64	1+1	12-20lb	SiC x 9
167-27-230	2.10	1.64	1+1	20-30lb	SiC x 9





## BIG GAME

X  
T  
R  
E  
M  
E  
A  
C  
T  
I  
O  
N



The Trabucco team of engineers designed this rod for heavy trolling. Blank is made from solid E-Glass, the best solution when you come to true fighting rods, with a fantastic parabolic action able to face with big pelagic predators. The range is wide, 3 models to cover all needs, and all models are equipped with roller guides. The Big game rods are suitable both for fast surface trolling and bluefin tuna drifting. Every roller is fixed to the blank with under wrapping to preserve it from breakage risk even during maximum

efforts. These rods feature aluminium reel seat, gimbal and slick butt handle.

Code	Size	C.Length	Sect.	Power	Guides
167-24-050	1.65	165	1	20/50lb	TRG X6
167-24-080	1.65	165	1	30/80lb	TRG X6
167-24-100	1.65	165	1	50/100lb	TRG X6



## SEAWOLF GOLD

Trabucco is the official distributor of the trolling and vertical jigging Maxel reels on Italian market.



Total reliability and strength are the two main targets which have driven the development and production of these reels, along with unique design, precision engineering and totally saltwater proof materials. Each single component has been created to give the best performance, being able to deal with the fastest runs of big sea fish.



**4** SHIELDED  
SS BALL  
BEARINGS

Find out more at page 199

# RUSHWAVE



## RUSHWAVE STRIKER

**XTREME ACTION** **NFC**  
NANO FIBER CARBON

A 2,10 meters rod dedicated to the trolling angler that likes to have onboard a high specification rod with medium progressive action and with an excellent power reserve. Designed by our experts for down rigger trolling with livebait, this rod is perfect for trolling with mullet, cuttlefish, squid or horse mackerel. It is equipped with an aluminium gimbal resistant to corrosion for durability and better fighting comfort. Despite the slim blank, the Rushwave is able to safely manage big fish like amberjack, grey snapper and

grouper, thanks to the Nano Fiber Carbon construction and double leg low profile SiC guides.



Code	Size	C.Length	Sect.	Power	Guides
167-44-210	2.10	115	2	12-20lb	SiC x 9

## RUSHWAVE POWER STICK

**XTREME ACTION**

### SPECIFICATIONS

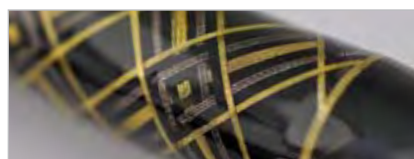

Usually light weight and power are specifications which can't live together in the same rod. But the new Rush Wave Power Stick, built from hollow E-Glass, succeeds to wonderfully combine them. The lighter models are just perfect for live bait trolling, using small diameter braided lines. This combination will allow to fish for snappers on rocky habitats. The 50 lbs version features a starting and top roller, to minimize line stress during strong fights with big fish. SiC guides are the correct complement and are suitable for braided lines. Every guide or roller is also under wrapped to protect the blank when it's extremely bent. Aluminium gimbal butt.



Code	Size	C.Length	Sect.	Power	Guides
167-46-012	1.80	145	1+1	12lb	SiC x 7
167-46-020	1.80	145	1+1	20lb	SiC x 7
167-46-030	1.80	145	1+1	30lb	SiC x 7
167-46-050	1.80	145	1+1	50lb	SiC+TRG x 7





## ARUBA TROLLING

**XTREME ACTION** **NFC**  
NANO FIBER CARBON

Owning a Travel trolling rod which has a total length of 215 cm with a one section rod action has always been the dream of every fisherman. Finally, thanks to careful design of the Trabucco's engineers, everything is now possible. With NFC technology (Nano Carbon Fiber), it has been possible to obtain a 5 sections rod with spigot joints which has a parabolic and progressive action subject of such power that rivals the more famous one-piece currently available in the market. Offering 20-30 lbs test curve, is extremely versatile for a trolling technique, ranging from lead guard, down rigger and live bait surface trolling. Comfort and technology for a rod that can not miss in any traveller's luggage. Supplied with a stiff cordura tube for safe transportation.



Code	Size	C.Length	Sect.	Power	Guides
167-31-100	2.15	52	6	20-30lb	Sic x 10



## MERIDIAN FIGHTER STAND UP

**XTREME ACTION** **E-GLASS**  
**BLANK**

The Trabucco Meridian series is made of composite super durable and reliable E-Glass, finished according to the method of superimposed layers to get an action equivalent to that of a much higher priced rod. It is therefore a very funny rods which leaves space to the fight with the fish, while maintaining an exceptional reserve of power in the lower part of the blank. The series includes 6 actions to cover at their best different fishing conditions, from mackerel to bonito, from dolphin fish to his majesty the bluefin tuna. The first two rods of the series, 12-16lb and 16-20lb, have been fitted with HD salt water resistant S-SiC guides. The next two actions 20-30 and 30-50 lbs fit a TRG HD roller on top for better management of

large diameter's nylon and also features a reinforced safety reel seat. Finally the 50-80 lbs, designed for bluefin tuna fishing, carries two TRG HD rollers (the first and the last) to cover the points of greatest friction, and a reinforced safety reel seat. The price will surprise you.

Code	Size	C.Length	Sect.	Power	Guides
167-41-016	1.65	165	1	12/16lb	Sic x 8
167-41-020	1.65	165	1	16/20lb	Sic x 8
167-41-030	1.65	165	1	20/30lb	Sic+TRG x 8
167-41-050	1.65	165	1	30/50lb	Sic+TRG x 7
167-41-080	1.65	165	1	50/80lb	Sic+TRG x 7



## SKIPJACK

XTREME  
ACTION

Skipjack has been designed to satisfy the highly-demanding anglers who look for a stand-up rod with the sensitivity of a standard long trolling model. With the size slightly longer than normal stand-ups and their special blank construction, these rods perfectly combine the best of both worlds. Sensitive tip, length around 170 cm and powerful back bone are the winning details of this multi-purpose rod series. The 6-12, 12-20 and 20-30 lbs rods, structured with hollow blank and carrying SiC guides, are suggested for live bait surface trolling to catch bluefish and snappers. The 30-50 lbs rod has a solid blank and full rollers to face long and tough fighting with giant tuna.

Code	Size	C.Length	Sect.	Power	Guides
167-39-012	1.65	165	1	6/12lb	SiC x 7
167-39-020	1.65	165	1	12/20lb	SiC x 7
167-39-030	1.65	165	1	20/30lb	SiC x 7
167-39-050	1.65	165	1	30/50lb	TRG x 5

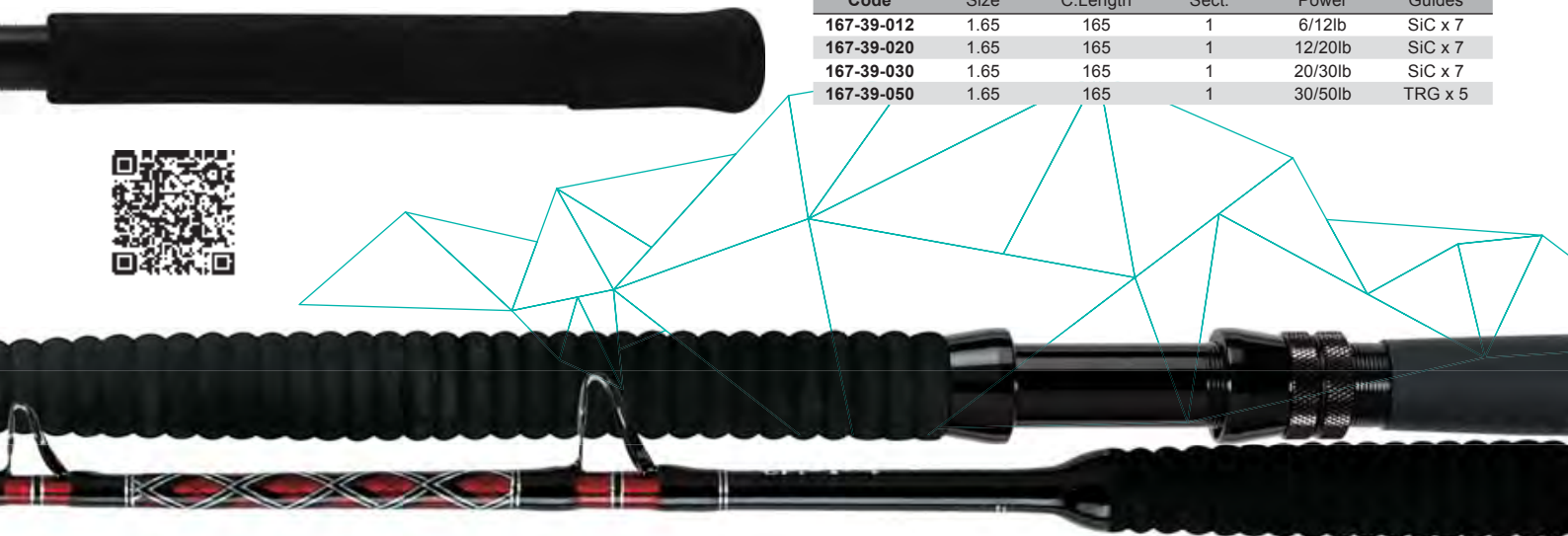

## TRIDENT TROLLING

XTREME  
ACTION

Small family of two 1+1 rods with an extremely amusing action, thanks to a blank that allows a sporting and sensitive fight with the fish. The tip of this rod, made from solid fiberglass, matches perfectly with the rest of the blank, and this is the secret of the nice combination between sensitivity and strength of the whole rod. The Trident rod is the one that everybody would like to have

to practice inshore trolling for bonito and other predators. Reel seat and gimbal made from hard graphite. Heavy duty stainless steel SiC guides can be used with braided lines, and are fixed by double wrapping.

Code	Size	C.Length	Sect.	Power	Guides
167-34-112	6' (1.83)	150	1+1	6/12	S-SiC x 8
167-34-120	6' (1.83)	150	1+1	12/20	S-SiC x 8
167-34-130	6' (1.83)	150	1+1	20/30	S-SiC x 8

Gimbal butt with tailor made rubber cap.





Saverio Rosa

**NEW** TSUNAMI FIGHTER

**XTREME ACTION** E-GLASS BLANK



The configuration of two equal length sections gives this light rod a particularly compact closed length, which is certainly welcomed by anglers who don't have high class boats. Ideal for inshore trolling, it is built from E-glass to withstand extreme curves and fits strong double leg guides with SIC ring, while the screw type reel seat has reliable steel hoods. The handle includes a long EVA fore grip, shaped at the bottom side in order to allow a secure grip. The EVA butt grip ends with a rubber cap, which in case of need disclose the gimbal butt. The wide power range (12/30 lbs) shows that it's a very versatile rod, to be successfully used in both shallow coastal trolling with live bait to catch Bluefish and Leerfish, and trolling with medium sized minnows, or even in the night fishing for Squid.



Code	Size	C.Length	Sect.	Power	Guides
167-32-100	6' (1,80)	100	2	12/30	S-SiC
167-32-200	7' (2,10)	106	2	12/30	S-SiC

TSUNAMI TROLLING

**XTREME ACTION**

Stand-up series of rods with fast action. The family is made of 2 models of 6'6" and 2 of 7', very good for trolling with live bait close to the bottom. The ergonomic handle allows to apply all the cranking power to the rod and reel complex, exploiting all the force of the angler. The reels seat and the gimbal are made from extra stiff graphite. The reliable and light weight blank is just perfect for Mediterranean Sea trolling.



Thanks to the special frame shape, guides and top guide are amazingly strong. Double wrappings.



Strong reel seat made from graphite and steel, fitted upside down for extreme strength.



Code	Size	C.Length	Sect.	Power	Guides
167-38-130	6'6" (1.98)	165	1+1	12/30	S-SiC x 8
167-38-140	6'6" (1.98)	165	1+1	15/40	S-SiC x 8
167-38-230	7' (2.10)	175	1+1	12/30	S-SiC x 8
167-38-240	7' (2.10)	175	1+1	15/40	S-SiC x 8

# NEPTUNE

## NEPTUNE TROLLING

X TREME  
ACTION

New series dedicated to small and medium coastal trolling. This rod has a very amusing parabolic action, able to satisfy those anglers who like to have more contact with the prey and then derive more satisfaction. On the other hand such an action allows to face fights with greater security and because of the perfect curve of the blank it is possible to fight fish even larger than the power of the blank would let you imagine. Despite the affordable price, the Neptune Trolling maintain high quality standards, such as the aluminium gimbal and braided-proof guides with under wrappings. Such details are unmatched in rods with similar price range!



Code	Size	C.Length	Sect.	Power	Guides
167-33-112	1.80	180	1	6/12lb	S-SiC x 7
167-33-120	1.80	180	1	12/20lb	S-SiC x 7
167-33-130	1.80	180	1	20/30lb	S-SiC x 7

## NEPTUNE MARINER

X TREME ACTION E-GLASS  
BLANK

Series of hybrid rods, suitable both for heavy bottom fishing and trolling, and able to face epic fights with really big fish. To highlight this double use, Trabucco printed on blank both trolling power and casting weight. The 180 cm blank is built in one piece and each guide has been wrapped and under wrapped for

increased safety. Neptune Marine rods feature DPS reel seat and braided-proof guides.



Code	Size	C.Length	Sect.	Power	Guides
167-36-020	1.80	180	1	12/20lb	S-SiC x 6
167-36-030	1.80	180	1	20/30lb	S-SiC x 6

## NEPTUNE SR

- All the gears are salt water treated and perform a 3.8:1 gear ratio, the correct compromise between speed and power.
- Both sizes feature level wind for an easy use and perfect line lay.
- Graphite body is light weight and corrosion resistant.

Very simple and easy to use, reliable and durable. In a few words the complete description of these good multipliers by Trabucco. The gear ratio, which is relatively low, enables the reel to develop high retrieving power, while the level-wind assists the newcomer and the occasional user. Perfect to match the Neptune trolling rods, these reels are particularly elegant and offer a total protection against saltwater.



Find more at page 201





# HOBBY

When fishing is pure pleasure, what counts is to get fun without investing a fortune. So one of these reliable rods is more than enough: just add a Trabuc-

co reel, some good advice from the retailer and... go fishing!

## ACCORD BOLO



A bolognese rod to be stored in the car's booth, ready to face any event, including the injuries the children will reserve it. The Accord is a simple and reliable rod, which just needs one of those pre-spooled Auris or Regent Trabucco reel to make everybody happy.

Code	Size	C.Length	Sect.	Guides
163-74-300	3.00	115	3	S-SiC
163-74-400	4.00	115	4	S-SiC
163-74-500	5.00	115	5	S-SiC

## EXPANDER BOLO & POLE



Telescopic rods with small closed length, made in Powerfibre. Strong and reliable, these cheap tools are ideal for to get started in the fascinating world of fishing in fresh and salt waters.

### EXPANDER BOLO

Code	Size	C.Length	Sect.	Guides
163-72-300	3.00	115	3	S-SiC
163-72-400	4.00	115	4	S-SiC
163-72-500	5.00	115	5	S-SiC
163-72-600	6.00	115	6	S-SiC

### EXPANDER POLE

Code	Size	C.Length	Sect.
163-71-300	3.00	115	3
163-71-400	4.00	115	4
163-71-500	5.00	115	5
163-71-600	6.00	115	6

## DEMON CARP TELE



Three different sizes for this telescopic rod series. Extremely strong thanks to the Powerfibre construction, they can be used with big sized elastic. These rods are made for all the people who love margin fishing in carp fisheries, available in size 1.80, 2.40 and 3.00m.

Code	Size	C.Length	Sect.
163-31-180	1.80	67	3
163-31-240	2.40	67	4
163-31-300	3.00	67	5

## DEMON CARP MARGIN POLE



Series of short margin pole designed for heavily stocked carp fisheries. The blank is extremely strong and totally reliable thanks to the full Power Glass construction, this allows big sized elastics to be used to fight even the toughest fish.

Code	Size	C.Length	Sect.
163-33-300	3.00	120	3
163-33-400	4.00	120	4

## DEMON FEEDER



The Demon Series has been designed for feeder fishing in lake, canal or river. The super resistant blank is made of HRC, a light weight and reliable composite material. Every model is equipped with two tips, both with the same action but having different power. The rods features S-SiC guides, really useful to disperse heat during prolonged fights.

Code	Model	Size	C.Length	Sect.	Action	C.W.	Guides
163-25-330	Carp	3.30	116	3+2	MH	90	S-SiC
163-25-360	Carp	3.60	126	3+2	MH	90	S-SiC
163-26-360	Power	3.60	126	3+2	H	120	S-SiC
163-26-390	Power	3.90	136	3+2	H	120	S-SiC
163-27-360	River	3.60	126	3+2	HH	150	S-SiC
163-27-390	River	3.90	136	3+2	HH	150	S-SiC



**NEW** SONIC XS



Telescopic series, in which even the sensitive fiberglass tip comes off second section by telescopic joint. An essential feature, for a simple but effective and versatile rod, suitable for feeder fishing but also for bottom fishing. From shore or by boat, on the river, lake or sea, the Sonic can face any condition with its HVE fiberglass blank, reinforced by an external cross-band braid.

Code	Size	C.Length	C.W.	Sect.	Guides
152-65-300	3,00	104	20-150 g	5	S-SiC
152-65-350	3,50	122	20-150 g	5	S-SiC

**POWER TELE**

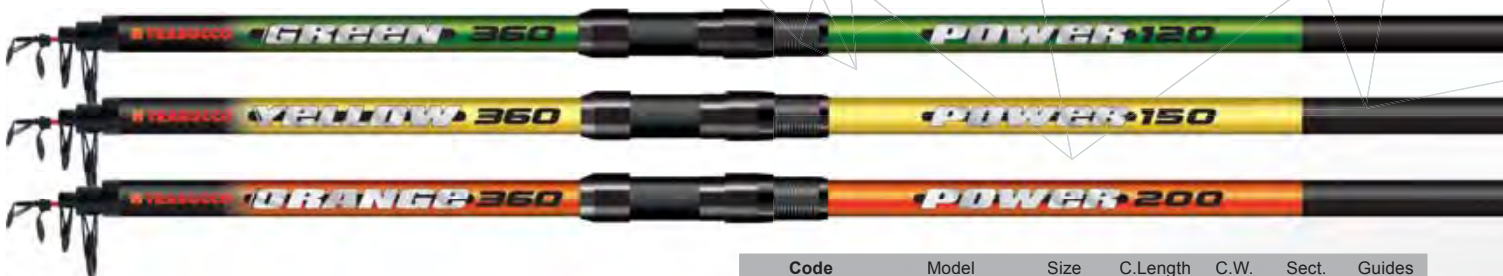

A comprehensive range of telescopic rods destined to bottom fishing with leads ranging from 120 to 200 grams weight, both in fresh and saltwater. Made from Powerfibre to grant strength and durability, they fit metal frame guides and screw reel seat with steel hoods. Yellow, green and orange colour help to identify their casting weight. The closed length is quite short to ease the transport.

Code	Model	Size	C.Length	C.W.	Sect.	Guides
165-70-120	Green Power	3.6	110	120	4	S-SiC
165-70-125	Green Power	3.9	110	120	4	S-SiC
165-70-160	Yellow Power	3.6	110	150	4	S-SiC
165-70-165	Yellow Power	3.9	110	150	4	S-SiC
165-70-200	Orange Power	3.6	110	200	4	S-SiC
165-70-205	Orange Power	3.9	110	200	4	S-SiC

**REVENGE WRC**



Series of telescopic rods extremely durable and reliable, made of Powerfibre, powerful but lightweight material. They are equipped with S-SiC guides and sliding guides, plus shock absorber reel seat.

Code	Model	Size	C.Length	Sect.	Guides
165-40-300	Seabass 120	3.00	107	4	S-SiC
165-40-350	Seabass 120	3.50	107	4	S-SiC
165-41-300	Seabream 150	3.00	107	4	S-SiC
165-41-350	Seabream 150	3.50	107	4	S-SiC

Code	Model	Size	C.Length	Sect.	Guides
165-42-300	Saragus 200	3.00	107	4	S-SiC
165-42-350	Saragus 200	3.50	107	4	S-SiC
165-43-300	Carp 150	3.00	107	4	S-SiC
165-43-350	Carp 150	3.50	107	4	S-SiC

**REVENGE WRC SPIN**



Very light but actually unbreakables, these 2-section rods are able to satisfy the newbies of predator fishing with very good actions. The PW (Power) versions are much more powerful and dedicated to salt water and silure fishing. The S-SiC guides allow the use of braided lines.

Code	Model	Size	C.Length	Sect.	Guides
163-43-240	2.40	126	2	80	S-SiC
163-43-270	2.70	141	2	80	S-SiC

Code	Size	C.Length	Sect.	C.W.	Guides
163-42-210	2.10	111	2	30	S-SiC
163-42-215	2.10	111	2	45	S-SiC
163-42-240	2.40	126	2	30	S-SiC
163-42-243	2.40	126	2	45	S-SiC
163-42-245	2.40	126	2	60	S-SiC
163-42-270	2.70	141	2	30	S-SiC
163-42-273	2.70	141	2	45	S-SiC
163-42-275	2.70	141	2	60	S-SiC